





XC1008D-XC1011D- XC1015D and VGC810 (FW rel. 1.8)

INDEX

1.	GENERAL WARNING	4
1.1	 PLEASE READ BEFORE USING THIS MANUAL	4
1.2	 SAFETY PRECAUTIONS	4
2.	CORRECT COMBINATION OF THE XC1000D –VGC810	5
3.	WIRING CONNECTIONS	6
3.1	XC1008D	6
3.2	XC1011D	7
3.3	XC1015D	8
3.4	DESCRIPTIONS OF THE WIRING CONNECTIONS	8
4.	USER INTERFACE	10
4.1	WHAT IS DISPLAYED WHEN THE KEYBOARD IS CONNECTED	10
4.2	DISPLAY VISUALIZATION	11
4.3	PROGRAMMING	13
5.	SERVICE MENU	16
5.1	HOW TO ENTER THE SERVICE MENU	16
5.2	HOW TO PROGRAM AN INSTRUMENT USING A HOT KEY	17
5.3	HOW TO SEE THE VALUES OF ANALOG OUTPUTS	17
5.4	HOW TO SEE THE STATUS OF THE RELAYS	18
5.5	COMPRESSOR SERVICE SUB- MENU – FOR MAINTENANCE SECTIONS	18
5.6	HOW TO SEE THE STATUS OF DIGITAL INPUTS	20
5.7	HOW TO SEE THE VALUES OF THE PROBES	21
5.8	HOW TO SET TIME AND DATE	21
5.9	HOW TO CHECK THE SUPERHEAT VALUE	22
6.	ALARMS	23
6.1	MENU ACTIVE ALARMS	23
6.2	ACTIVE ALARM LOG MENU	24
6.3	ACTIVE ALARM LOG MENU	24
7.	PARAMETERS	25
8.	REGULATION	45
8.1	NEUTRAL ZONE ADJUSTMENT – ONLY FOR COMPRESSORS	45
8.2	PROPORTIONAL BAND ADJUSTMENT – FOR COMPRESSORS AND FANS	46
9.	SCREW COMPRESSORS	48
9.1	REGULATION WITH SCREW COMPRESSORS LIKE BITZER/ HANBELL/ REFCOMP ETC	48
9.2	REGULATION WITH SCREW COMPRESSORS LIKE FRASCOLD	48

10.	<u>ANALOG OUTPUTS FOR INVERTER</u>	49
10.1	COMPRESSOR MANAGEMENT	49
10.2	FANS MANAGEMENT WITH INVERTER– 1 FANS GROUP WITH INVERTER MODE, OTHERS ON IN ON/OFF MODE	50
10.3	MANAGEMENT OF ALL FANS WITH INVERTER – PROPORTIONAL INVERTER	51
10.4	LIQUID INJECTION VALVE ACTIVATION FOR RAISING SUPERHEAT – SUBCRITICAL CO2 APPLICATION	52
10.5	TEMPERATURE/PRESSURE VALUE AT WHICH TO TURN OFF THE COMPRESSORS (ELECTRONIC PRESSURE SWITCH).	53
10.6	PLANT WITH PROBE INPUT 63 –64: (SUCTION PROBE – CIRCUIT 2) AS INPUT FOR DYNAMIC SET OF SUCTION 1	53
11.	<u>ALARM LIST</u>	54
11.1	ALARM CONDITIONS – SUMMARY TABLE	54
12.	<u>CONFIGURATION ERRORS</u>	56
13.	<u>MOUNTING & INSTALLATION</u>	57
13.1	XC1000D DIMENSIONS	57
13.2	VG810 DIMENSIONS AND MOUNTING	58
14.	<u>ELECTRICAL CONNECTIONS</u>	59
14.1	PROBES CONNECTION	59
15.	<u>RS485 SERIAL LINK</u>	59
16.	<u>TECHNICAL FEATURES</u>	60
17.	<u>DEFAULT SETTING</u>	61

1. GENERAL WARNING

1.1 Please read before using this manual

- This manual is part of the product and should be kept near the instrument for easy and quick reference.
- The instrument shall not be used for purposes different from those described hereunder. It cannot be used as a safety device.
- Check the application limits before proceeding.
- Dixell Srl reserves the right to change the composition of its products, even without notice, ensuring the same and unchanged functionality

1.2 Safety Precautions

- Check the supply voltage is correct before connecting the instrument.
- Do not expose to water or moisture: use the controller only within the operating limits avoiding sudden temperature changes with high atmospheric humidity to prevent formation of condensation
- Warning: disconnect all electrical connections before any kind of maintenance.
- The instrument must not be opened.
- In case of failure or faulty operation send the instrument back to the distributor or to "DIXELL s.r.l." (see address) with a detailed description of the fault.
- Consider the maximum current which can be applied to each relay (see Technical Data).
- Ensure that the wires for probes, loads and the power supply are separated and far enough from each other, without crossing or intertwining.
- Fit the probe where it is not accessible by the end user.
- In case of applications in industrial environments, the use of mains filters (our mod. FT1) in parallel with inductive loads could be useful.

2. CORRECT COMBINATION OF THE XC1000D –VGC810



The regulator and keyboard are matched according to code. Always check the labels: version 1.8 of the XC1000D requires BIN version 2.8 of the keyboard:

XC1000D: check the version specified on the label is **V1.8**

VGC810: check the version specified on the label is **BIN: 2.8**

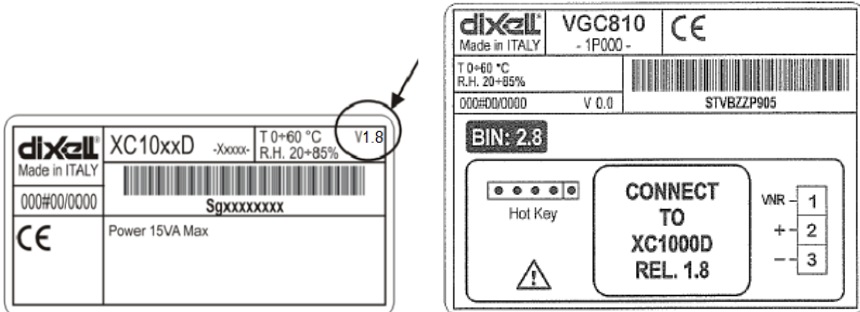

REPLACEMENT WITH MONITORING SYSTEM

To replace a compressor rack, you need to check the XWEB monitoring libraries. If the version you install is not the same as the previous one, you need to insert the respective library in the XWEB.

3. WIRING CONNECTIONS

3.1 XC1008D

XC1008D

SAFETY DIGITAL INPUTS

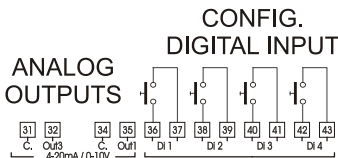
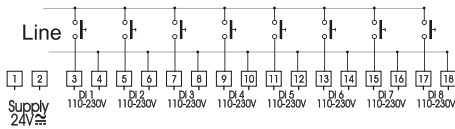

SAFETY DIGITAL INPUTS

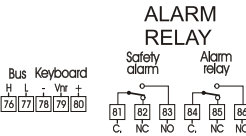
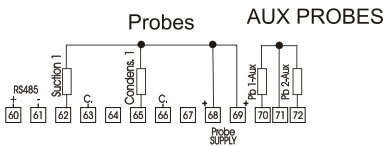
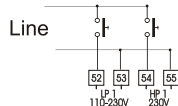

HOT KEY

OUTPUT RELAYS

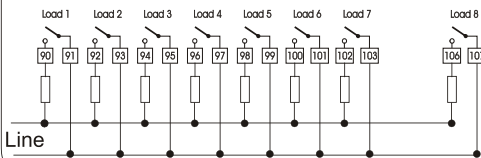

NOTE: according to the models the **digital inputs:** (3-18) and (52-55) can operate at 230V/120V or 24V. Verify on the controller which is the right voltage that can be applied.

ATTENTION

Configurable digital inputs (term. 36-43) are free voltage.

3.2 XC1011D

XC1011D

SAFETY DIGITAL INPUTS

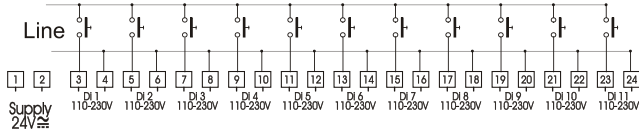

CONFIG. DIGITAL INPUT

ANALOG OUTPUTS

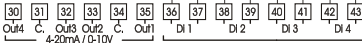

SAFETY DIGITAL INPUTS

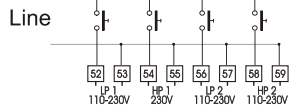

Probes

AUX PROBES

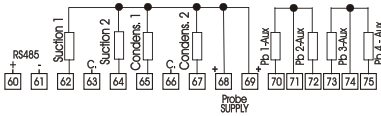

ALARM RELAY

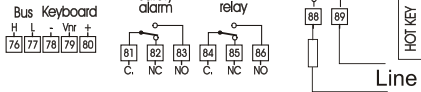

OUTPUT RELAYS

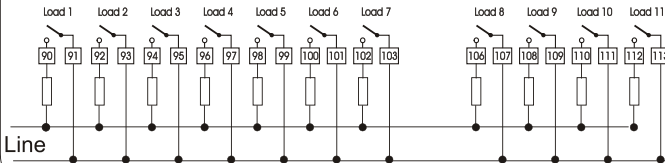

NOTE: according to the models the **digital inputs:** (3-24) and (52-59) can operates at 230V/120V or 24V. Verify on the controller which is the right voltage that can be applied.

ATTENTION

Configurable digital inputs (term. 36-43) are free voltage.

3.3 XC1015D

XC1015D

SAFETY DIGITAL INPUTS

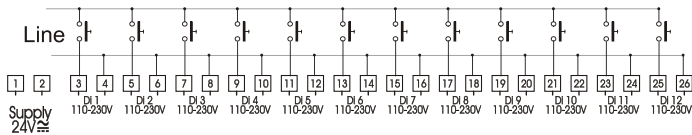

CONFIG. DIGITAL INPUT

ANALOG OUTPUTS



SAFETY DIGITAL INPUTS

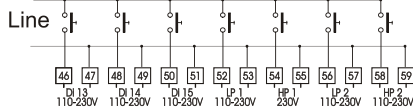

Probes

AUX PROBES

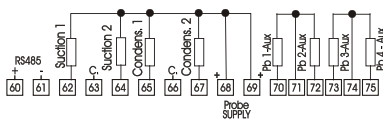

ALARM RELAY

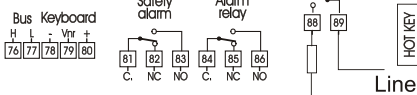

OUTPUT RELAYS

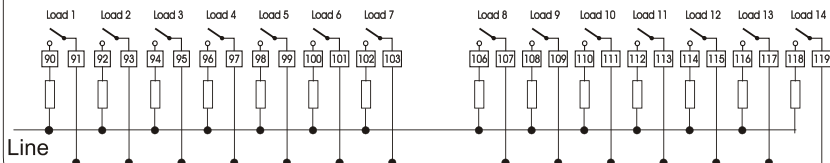

NOTE: according to the models the **digital inputs**: (3-26) and (46-59) can operate at 230V/120V or 24V. Verify on the controller which is the right voltage that can be applied.

ATTENTION

Configurable digital inputs (term. 36-43) are free voltage.

3.4 Descriptions of the wiring connections

1 - 2 Power supply: **WARNING:** THE SUPPLY IS 24Vac/dc

3 - 26 Digital inputs for safeties of compressors and fans – **main voltage**. When an d. i. is activated, the corresponding output is switched OFF. **Please note: the digital input 1 is linked to the relay 1 (C1); d.i. 2 to relay 2 (C2), etc.**

30-31 Analog output 4 (0-10V or 4-20mA depends on the parameter 3Q1)

31-32 Analog output 3 (0-10V or 4-20mA depends on the parameter 3Q1)
34-35 Analog output 1 (0-10V or 4-20mA depends on the parameter 1Q1)
33-34 Analog output 2 (0-10V or 4-20mA depends on the parameter 1Q1)

36-37 Configurable digital input 1 (free voltage)
38-39 Configurable digital input 2 (free voltage)
40-41 Configurable digital input 3 (free voltage)
42-43 Configurable digital input 4 (free voltage)

46-51 Digital inputs for safeties of compressors and fans – main voltage. When an d. i. is activated, the corresponding output is switched OFF. **Please note: the digital input 1 is linked to the relay 1 (C1); d.i. 2 to relay 2 (C2), etc.**

52 - 53 Low pressure-switch input for circuit 1: input at the same voltage of loads.

54 - 55 High pressure-switch input for circuit 1: input at the same voltage of loads.

56 - 57 Low pressure-switch input for circuit 2: input at the same voltage of loads.

58 - 59 High pressure-switch input for circuit 2: input at the same voltage of loads.

60-61 RS485 output

62 –(63) or (68): Suction probe input for circuit 1:
with **AI1 = cur** or **rat** use 62 -68
with **AI1 = ntc** or **ptc** use 62 -63

64 –(63) or (68): Suction probe input for circuit 2:
with **AI1 = cur** or **rat** use 64 -68
with **AI1 = ntc** or **ptc** use 64 -63

65 –(66) or (69): Condensing probe input for circuit 1:
with **AI8 = cur** or **rat** use 65 -69
with **AI8 = ntc** or **ptc** use 65 -66

67 –(66) or (69): Condensing probe input for circuit 2:
with **AI8 = cur** or **rat** use 67 -69
with **AI8 = ntc** or **ptc** use 67 -66

70-71 Auxiliary probe 1

71-72 Auxiliary probe 2

73-74 Auxiliary probe 3

74-75 Auxiliary probe 4

78- 79- 80 Keyboard

81-82-83: Safety relay: XC1000D off or damaged: 81-82 closed
XC1000D working: 81-83 closed

84-85-86: Alarm relay:

88 - 103 and 106 - 119 Relay configurable outputs for compressors, fans, alarms and aux.
The functioning of the relays depends on the setting of the correspondent C(i).

4. USER INTERFACE

4.1 What is displayed when the keyboard is connected



Where:

release: Rel Firmware XC1000D / release OS Visograph / release Program Visograph

Push the ENTER key to enter the standard visualization

4.2 Display visualization

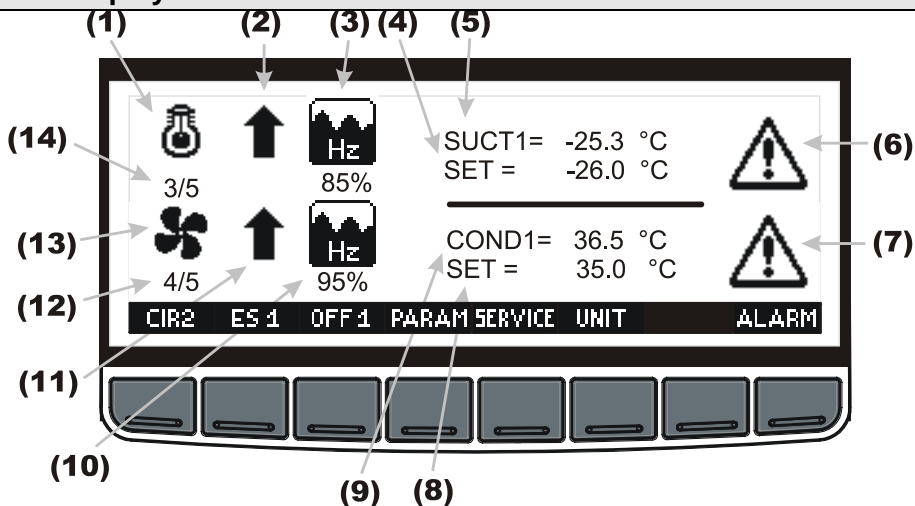

- (1) **Symbol of compressor:** it's present for the following configuration of the parameter C0. C0 = 1A0D; 1A1D, 2A0D, 2A1D, "2A2D
- (2) **Status of the suction section:**
 - ↓ The pressure (temperature) is below the regulation band and the capacity of the plant is decreasing
 - ↑ The pressure (temperature) is above the regulation band and the capacity of the plant is increasing
- (3) **Analog output status for frequency compressor:** it's present only if a frequency compressor is used. It displays the percentage of the analog output driving the inverter. Not present if the "free" analog output is used.
- (4) **Suction pressure (temperature) set point:** : it's present for the following configuration of the parameter C0: 1A0D; 1A1D, 2A0D, 2A1D, "2A2D
- (5) **Current value of suction pressure (temperature):** it's present for the following configuration of the parameter C0: 1A0D; 1A1D, 2A0D, 2A1D, "2A2D
- (6) **Alarm:** it's display when an alarm happens in suction section
- (7) **Alarm:** it's display when an alarm happens in delivery section
- (8) **Delivery pressure (temperature) set point:** it's present for the following configuration of the parameter C0: 0A1D; 1A1D, 0A2D, 1A2D, "2A2D
- (9) **Current value of delivery pressure (temperature):** it's present for the following configuration of the parameter C0: 0A1D; 1A1D, 0A2D, 1A2D, "2A2D
- (10) **Analog output status for inverter for fan:** it's present only if an inverter for fan is used.

It displays the percentage of the analog output driving the inverter.
Not present if the "free" analog output is used.

(11) Status of the delivery section:



The condenser pressure (temperature) is below the regulation band and the number of fans is decreasing



The condenser pressure (temperature) is above the regulation band and the number of fans is increasing

(12) Number of fans activated / Total number of fans it's present for the following configuration of the parameter C0.

C0: 0A1D; 1A1D, 0A2D, 1A2D, "2A2D

NOTE: the total number of fans is referred to the number of available fans. Fans that are in "maintenance" or that are stopped by their own digital input aren't included.

(13) Symbol of fan: it's present for the following configuration of the parameter C0.

C0: 0A1D; 1A1D, 0A2D, 1A2D, "2A2D

(14) Number of compressors and steps activated / Total number of compressors and steps. it's present for the following configuration of the parameter C0.

C0 = 1A0D; 1A1D, 2A0D, 2A1D, 2A2D

NOTE: the total number of compressors is referred to the number of available compressors. Compressors that are in "maintenance" or that are stopped by their own digital input aren't included.

Keys

ALARM

Alarm: to enter the alarm menu

PARAM

Parameter: to enter the parameter programming

SERVICE

Service: to enter the Service menu

UNIT

Measurement unit: to switch the probe visualization and set point from pressure to temperature and vice versa

OFF1

To switch the controller off: hold pushed for 10s to switch the controller off (it's enabled only if the parameter OT9 = yES)

ES 1

Energy saving: hold pushed for 10s to enable the energy saving cycle (the SET label starts flashing)

CIR2

Circuit 2: to pass to visualization of the variables of the second circuit, It's present for the following configuration of the parameter C0: 0A2D; 2A0D, 2A2D.

4.3 Programming

Push the **PARAM** key and the programming menu is entered.

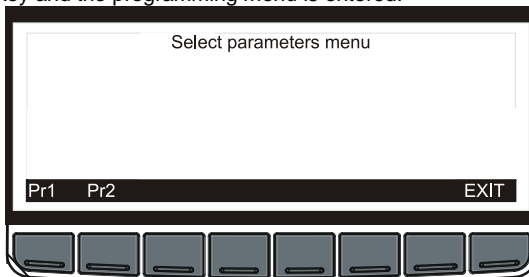

Parameters are collected in two menu:

Pr1: menu of parameters without password. Press the Pr1 key to enter.

Pr2: menu of parameters with password. If the password is enabled, use the following procedure to put it.

4.3.1 *Password introduction to enter Pr2*

If the password is enabled, by pushing the **Pr2** key the following interface is displayed:

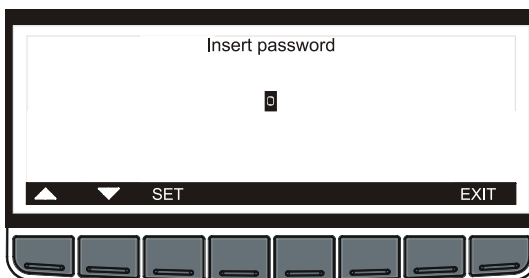

1. Push the SET key.
2. Use the UP and DOWN keys to set the password
3. Push the SET key to confirm it
4. The following message is displayed

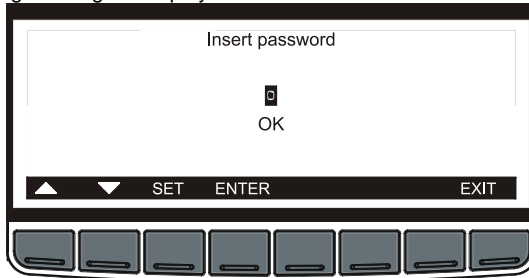

5. Push the ENTER key to enter in Pr2 menu

4.3.2 Parameters grouping

The parameters are collected in sub-menu according to the following interface.

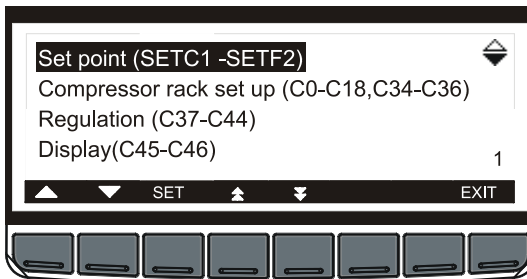

The parameters sub menu are the following:

Set Point (SETC1-SETF2)

Compressor Rack setup (C0-C18, C34-C36)

Regulation (C37-C44)

Display (C45-C46)

Analog Inputs of regulation (Ai1-Ai15)

Analog Inputs of auxiliary (Ai16-Ai28)

Safety Digital Inputs (Di2-Di13)

Digital Inputs (Di14-Di27)

Display (C45-C44)

Compressor Action (CP1-CP8)

Safety Compressors (CP9-CP18)

Fan Action (F1-F8)

- Safety Fans (F9-F10)
- Energy Saving (HS1-HS14)
- Compressor Alarms (AC1-AC19)
- Fan Alarms (AF1-AF17)
- Dynamic Setpoint Suction (o1-o8)
- Condenser Set point (O9-O14)
- Analog outputs configuration (1Q1, 3Q1)
- Analog Outputs 1 (1Q1-1Q26)
- Analog Outputs 2 (2Q1-2Q25)
- Analog outputs 3 (3Q2-3Q26)
- Analog outputs 4 (4Q1-4Q25)
- Auxiliary Outputs (AR1-AR12)
- Other (oT1-OT9)

NOTE: some sub menu could be absent depending on the model.

Push the SET key to enter a menu and the parameter with their value will be displayed: see below picture.

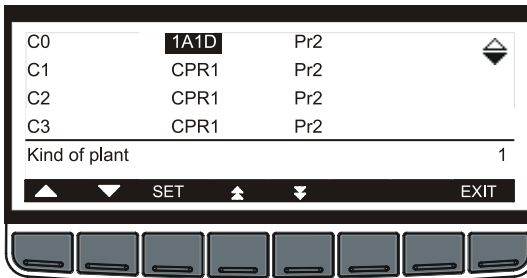

Push the **SET** key and use the **UP** and **DOWN** keys to modify the value.
Then push the **SET** key to store the new value and move to the following parameter.

NOTE: the Pr2 or Pr1 message is present only in Pr2 menu.
It is possible to modify the level of each parameter changing Pr2 → Pr1 or vice versa.

NOTE: Pushing the **EXIT** button the initial screen shot is displayed.

5. SERVICE MENU

The service menu collect the main functions of the controller.

From the Service menu is possible to:

- see the values of analog outputs
- see the status of compressor relay
- operate a maintenance section
- see the status of safety and configurable digital inputs
- see the values of the probes
- set the real time clock
- use the HOT KEY to program the instrument or to program the HOT KEY
- set the password and enable it for some menu
- set the instrument language.

5.1 How to enter the Service menu

From the main display screen push the SERVICE button and the SERVICE menu is entered.

See below picture:

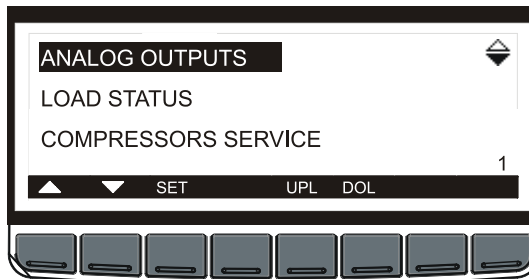

The Service sub-menu are the following:

ANALOG OUTPUTS
LOAD STATUS
COMPRESSOR SERVICE
DIGITAL INPUTS
PROBES
SUPERHEAT (with function enabled)
CLOCK
PASSWORD
LANGUAGE

Select one of them with the UP or DOWN keys then push the SET key to enter the sub-menu

5.2 How to program an instrument using a HOT KEY

The XC1000D uses a standard Dixell HOT KEY (cod. DK00000100).

5.2.1 How to program the HOT KEY.

1. Program one controller with the front keypad.
2. When the controller is ON, insert the “**Hot key**”. Enter the SERVICE menu and push the **UPL** key. The display will show the message “**PLEASE WAIT**”.
3. The instrument will show during 10sec:
“**END**”: the programming phase is ended successfully
the “**ERROR**” message is displayed for failed programming. In this case push again the UPL key if you want to restart the upload again.

5.2.2 How to program an instrument using a HOT KEY

1. Switch off the controller or enter the SERVICE menu.
2. Insert a **programmed “Hot Key” into the 5 PIN receptacle**
3. Turn the controller on, or push the DOL key of the SERVICE menu.
4. Automatically the parameter list of the “**Hot Key**” is downloaded into the Controller memory, the “**doL**” message is blinking. The display will show the message “**PLEASE WAIT**”.
4. The instrument will show during 10sec:
“**END**”: the programming phase is ended successfully.
Remove the “Hot Key”, the XC1000D will restart working with the new parameters.
NOTE: until the “Hot Key” is inserted, the instrument doesn’t start the regulation.
the “**ERROR**” message is displayed for failed programming. In this case push again the UPL key if you want to restart the upload again. After 10 seconds the instrument will restart working with the new parameters.

5.3 How to see the values of analog outputs

Procedure:

1. Enter the **SERVICE** menu
2. Select **ANALOG OUTPUTS** sub-menu
3. Push the **SET** key.

The **ANALOG OUTPUTS** sub-menu displays the status of the analog outputs of the controller, with the following layout:

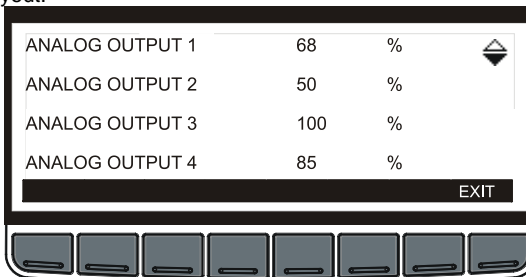

This outputs can be used to drive an external inverter or to repeat a main probe, by means of a signal 4-20mA or 0-10V.

5.4 How to see the status of the relays

Procedure:

1. Enter the **SERVICE** menu
2. Select **LOADS STATUS**
3. Push the **SET** key.

The **LOADS STATUS** sub-menu displays the status of the relays in the following format:

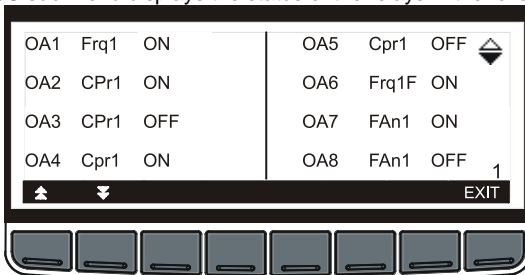

OA1	Frq1	ON		OA5	Cpr1	OFF	▲
OA2	CPr1	ON		OA6	Frq1F	ON	
OA3	CPr1	OFF		OA7	FAn1	ON	
OA4	Cpr1	ON		OA8	FAn1	OFF	1

Navigation icons: ▲, ▼, EXIT

With this meaning:

First column: number of relay; second column: configuration; third column: status.

5.5 Compressor service sub- menu – For maintenance sections

The **COMPRESSOR SERVICE** menu could be protected by password. See chapter 3.3.1.

By means of the **COMPRESSOR SERVICE** sub-menu is possible to perform a maintenance section, consisting on:

- disabled an output
- check and (eventually) erase the running hour of a load.

5.5.1 How to enter the “COMPRESSOR SERVICE” submenu.

Procedure:

1. Enter the **SERVICE** menu
2. Select **COMPRESSOR SERVICE** sub-menu
3. Push the **SET** key.

The **COMPRESSOR SERVICE** sub-menu displays the status of the relays with the following layout:

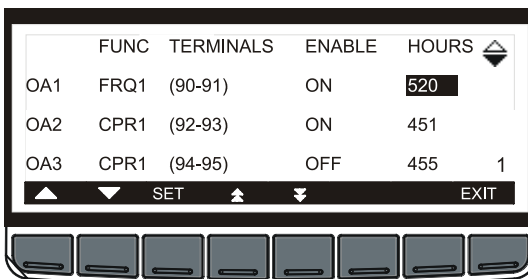

5.5.2 How to disabled/enabled an output during a maintenance section.

To disabled an output during a maintenance session means to exclude the output from the regulation:

To do it act as in the following

1. Enter the **COMPRESSOR SERVICE** sub-menu, as described in the previous paragraph.
2. Select the load by means of the UP and DOWN keys.
3. Push the SET key, then use the UP and DOWN keys to move the status to ON to OFF and vice versa.
4. Confirm the selection by means of the SET key.

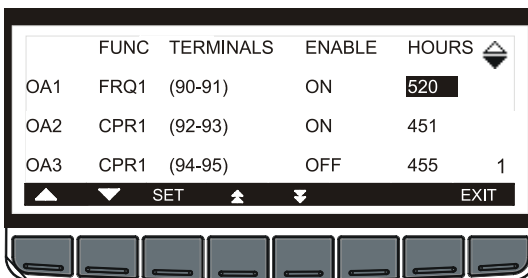

5.5.3 Regulation with some outputs disabled.

If some outputs are disabled they don't take part to the regulation, so the regulation goes on with the other outputs.

5.5.4 How to display the running hours of a load.

The controller memorises the running hours of each load.

To see how long a load has been working enter the **COMPRESSOR SERVICE** sub-menu.

The running hour are displayed with the following layout:

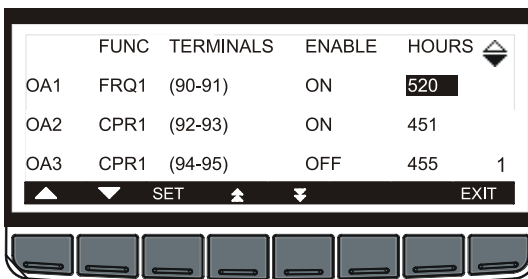

5.5.5 How to erase the running hours of a load

After a maintenance session usually is useful to erase the running our of a load.

To do it act as in the following

1. Enter the **COMPRESSOR SERVICE** sub-menu, as described in the paragraph. 5.5.1.
2. Select the load by means of the UP and DOWN keys.
3. Push the SET key, then use the DOWN key to decrease the running hour of the load..
4. Confirm the setting by means of the SET key.

To exit: push the **EXIT** key to come back to the SERVICE menu.

5.6 How to see the status of digital inputs

Procedure:

1. Enter the **SERVICE** menu
2. Select **DIGITAL INPUTS** sub-menu
3. Push the **SET** key.

The **DIGITAL INPUTS** sub-menu displays the status of the safety and configurable digital inputs, with the following layout:

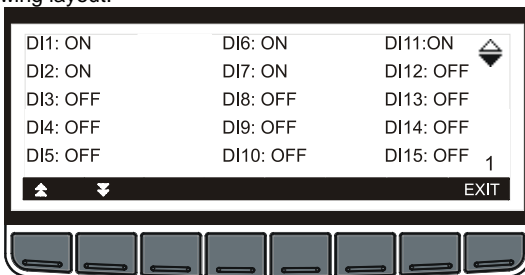

Safety digital inputs

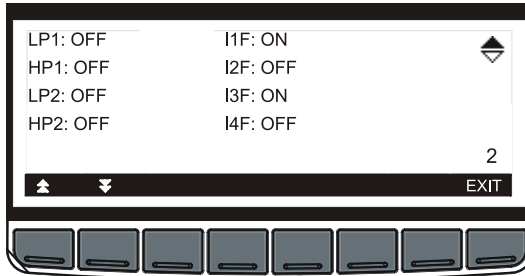

HP, LP and configurable inputs

5.7 How to see the values of the probes

Procedure:

1. Enter the **SERVICE** menu
2. Select **PROBES** sub-menu
3. Push the **SET** key.

The **PROBES** sub-menu displays the probe values, with the following layout:

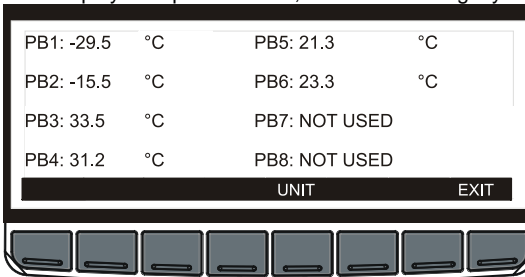

To **change** the measurement unit for the probe PB1, PB2, PB3, PB4, push **UNIT** button.

5.8 How to set time and date

Procedure:

1. Enter the **SERVICE** menu
2. Select **REAL TIME CLOCK** sub-menu
3. Push the **SET** key.

The **REAL TIME CLOCK** sub-menu displays time and date, with the following layout:

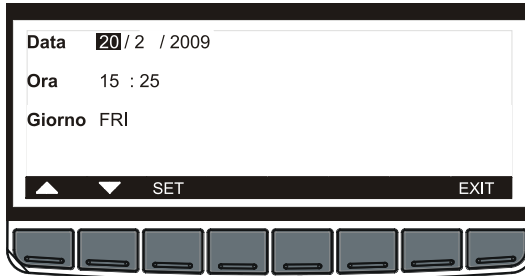

5. Set the day by means of the **UP** and **DOWN** keys.
6. Push the **SET** key, to confirm and pass to the setting of time.
7. Use the same procedure for the date.
8. Then confirm the selection by means of the SET key.

NOTE: to memorise the alarms and to enable the automatic energy saving cycle the real time clock has to be set.

5.9 How to check the superheat value

The additional temperature probes, Pb1 (70-71), Pb2 (71-72), Pb3 (73-74) and Pb4 (74-75), can be configured to calculate superheat of the suction circuit 1 or 2.

To do so, configure one of the following parameters

AI17	Function of auxiliary probe 1	as SH1 or SH2 opp.
AI20	Function of auxiliary probe 2	as SH1 or SH2 opp.
AI23	Function of auxiliary probe 3	as SH1 or SH2 opp.
AI26	Function of auxiliary probe 4	as SH1 or SH2 opp.

to calculate superheat for suction circuit 1 or 2.

To check the superheat value:

1. Open the **SERVICE** menu
2. Select **SUPERHEAT**
3. Press the **SET** button.

The superheat value is indicated in the **SUPERHEAT** sub-menu.

6. ALARMS

The controller memorises the last 100 alarms happened, together with their start and finish time. To see the alarms follow the following procedure.

6.1 Menu Active alarms

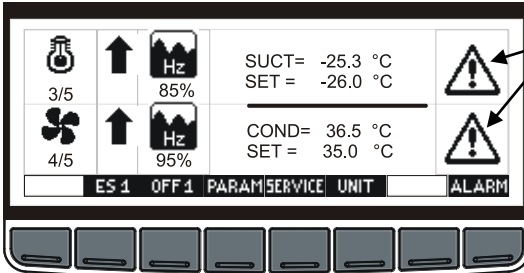

If the alarm icon is flashing on the main display, an alarm is occurring.

Push the **ALARM** key to enter the alarm menu.

1. Push the **ALARM** key to enter the **ALARM MENU**,
2. Select the alarm menu

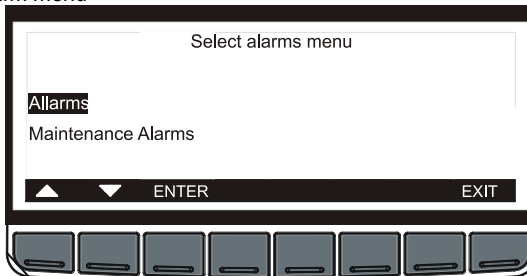

Premere il tasto **ENTER** per entrare nel menu allarmi

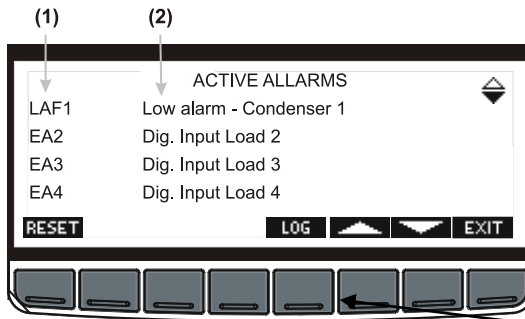

The alarm menu displays the active alarm with the following layout:

(1) = alarm code

(2) = alarm description

Push the **LOG** button to enter the **ALARM ACTIVE** log, as shown in the following picture

6.2 Active alarm log menu

This menu contains all the information concerning the active alarms. In the first line, it is displayed how many alarms are happening.

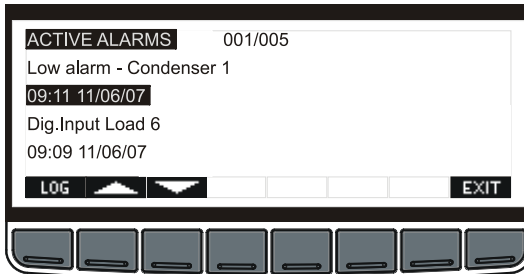

It's possible to move through the alarms by the UP and DOWN keys.

6.3 Active alarm log menu

Push the **LOG** button to enter the **ALARM LOG**.

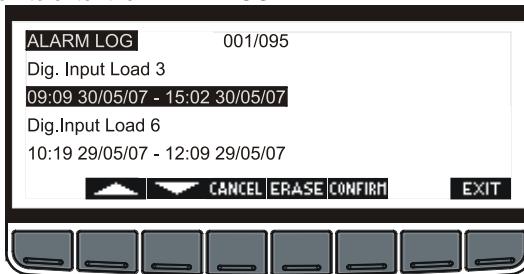

This menu contains all the memorised alarms. For each alarm the starting time and date and the finish time and date are recorded.

Push the **ERASE** button to delete the whole archive of alarms. The following display is shown:

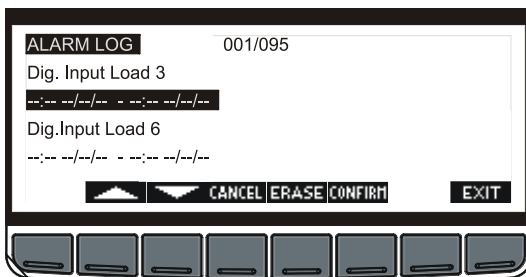

Push the **CONFIRM** button to confirm the operation and delete the archive.
 Push the **CANCEL** button to cancel the operation and come back to the ALARM LOG menu.

7. PARAMETERS

7.1.1 Compressor Rack setup (C0-C18, C34-C36)

C0 **Kind of plant:** it set the kind of plant.

The following table shows the kind of plant can be set and which probes have to be used

C0	Kind of plant	Pb1	Pb2	Pb3	Pb4
0A1d	Only condenser fan	-	-	Delivery 1	-
1A0d	Only compressors	Suction 1	-	-	-
1A1d	Compressors and fans 1 circuit	Suction 1	-	Delivery 1	-
0A2d	Fans of circuit 1 and 2	-	-	Delivery 1	Delivery 2
2A0d	Compressors of circuit 1 and 2	Suction 1	Suction 2	-	-
2A1d	Compressors of circuit 1 and 2 – 1 condenser	Suction 1	Suction 2	Delivery 1	-
2A2d	Compressors of circuit 1 and 2 – Fans of circuit 1 and 2	Suction 1	Suction 2	Delivery 1	Delivery 2
1A1dO	Compressors and fans – 1 circuit	Suction 1	For optimizing suction 1	Delivery 1	-

C1... C15 Relay 1...15 configuration: by means of parameter **C0** and **C1...C15** the plant can be dimensioned according to the number and type of compressors and/or fans and the number of steps for each one.

Each relay according to the configuration of the C(i) parameter can work as

Frq1 = frequency compressor circuit 1;

Frq2 = frequency compressor circuit 2;

CPr1 = compressor circuit 1;

CPr2 = compressor circuit 2,

Screw1 = screw compressor – circuit 1

Screw2 = screw compressor – circuit 2

StP = step of the previous compressor,

FrqF1 = inverter fan circuit 1;
FrqF2 = inverter fan circuit 2;
FAn1 = fan circuit 1,
FAn2 = fan circuit 2,
ALr = alarm;
ALr1 = alarm 1
ALr2 = alarm 2
AUS1 = auxiliary output 1
AUS2 = auxiliary output 2,
AUS3 = auxiliary output 3,
AUS4 = auxiliary output 4,
onF = on / off relay
Valv1 = valve for injecting liquid to increase superheat – circuit 1
Valv2 = valve for injecting liquid to increase superheat – circuit 2
nu = relay not used

NOTE 1: CIRCUITS WITH INVERTER FOR COMPRESSORS OR FANS

If in one circuit there are frequency compressors (Frq1 or Frq2) inverter fans, (Frq1F or Frq2F) their relays must be the first of that circuit.

ES: Plant with 1 circuit with 6 compressors (1 with inverter and 5 fans with inverter):

C0 = 1A1d;
C1 = Frq1;
C2 = CPr1;
C3 = CPr1,
C4 = CPr1,
C5 = CPr1;
C6 = CPr1;
C7 = Frq1F;
C8 = FAn1;
C9 = FAn1;
C10 = FAn1;
C11 = FAn1;
C12 = nu
C13 = nu
C14 = nu
C15 = nu

PLANT CONFIGURATION EXAMPLE:

Plant with 1 circuit with 6 compressors e 5 fans:

C0 = 1A1d;
C1 = CPr1;
C2 = CPr1;
C3 = CPr1,
C4 = CPr1,
C5 = CPr1;
C6 = CPr1;
C7 = FAn1;
C8 = FAn1;
C9 = FAn1;
C10 = FAn1;
C11 = FAn1;
C12 = nu
C13 = nu
C14 = nu
C15 = nu

Plant with 1 circuit with 3 compressors, 2 of them without valves, and 1 compressor with 2 valves e 4 fans:

C0 = 1A1d;
C1 = CPr1;
C2 = CPr1;
C3 = CPr1,
C4 = Stp,
C5 = Stp;
C6 = FAn1;
C7 = FAn1;
C8 = FAn1;
C9 = FAn1;
C10 = nu
C11 = nu
C12 = nu
C13 = nu
C14 = nu
C15 = nu

Plant with 2 suctions and 2 deliveries:

Suction 1: 1frequency compressor, 1 compressor without valves and 1 compressors with 2 valves

Delivery 1: 3 fans

Suction 2: 1frequency compressor, 2 compressors

Delivery 2: 1 inverter fan, 2 fans

C0 = 2A2d;
C1 = Frq1;
C2 = CPr1;
C3 = CPr1,
C4 = Stp,
C5 = Fan1;
C6 = FAn1;
C7 = FAn1;
C8 = Frq2;
C9 = Cpr2;
C10 = Cpr2;
C11 = Frq2F;
C12 = Fan2;
C13 = Fan2;
C14 = nu
C15 = nu

C16 Kind of compressors: to set the kind of compressors.

SPo = compressors with the same capacity.

BitZ = screw compressors like Bitzer, Hanbell, Refcomp etc operation.

FrzZ = screw compressors like Frascold operation.

C17 Valve output polarity - circuit 1: valve polarity: polarity of the outputs for capacity valves. It determines the state of the relays associated with the capacity valves:

oP=valve enabled with open contact;

cL= valve enabled with closed contact.

C18 Valve output polarity - circuit 2: valve polarity: polarity of the outputs for capacity valves. It determines the state of the relays associated with the capacity valves:

oP=valve enabled with open contact;

cL= valve enabled with closed contact.

C34 Kind of gas for circuit 1: set the kind of refrigerant used in the circuit 1

By setting the kind of gas, the XC1000D associate the pressure with the temperature.

*** NOTE: if a also the circuit 2 is present the refrigerant used in the circuit 2 has to be set by the parameter C47 ***

The following table show the refrigerant gases managed by XC1000D series, with their operating range

LABEL	REFRIGERANT	OPERATING RANGE
R22	r22	-50-60°C/-58÷120°F
r134	r134A	-70-60°C/-94÷120°F
r404A	r404A	-50-60°C/-58÷120°F
r407A	r407A	-50-60°C/-58÷120°F
r410	r410	-50-60°C/-58÷120°F
r507	r507	-70-60°C/-94÷120°F
r407C	r407C	-50-60°C/-58÷120°F
r407F	r407F	-50-60°C/-58÷120°F
r290	r290 – Propane	-50-60°C/-58÷120°F
CO2	r744 - Co2	-50-30°C/-58÷86°F
r450A	r450A	-45-60°C/-69÷120°F
r513	r513	-45-60°C/-69÷120°F
r448	r448A	-45-60°C/-69÷120°F
r449	r449A	-45-60°C/-69÷120°F
r32	r32	-55-60°C/-94÷120°F
r1234ze	r1234ze	-18÷50°C/0÷122°F
717	717	-50-60°C/-58÷120°F

- C35 **Activation time during the switching on of first step (valve of 25%) for Bitzer screw compressors:** (0÷255s): it sets for how long the valve is used during the startup phase.
- C36 **First step enabled during the regulation (switching off phase):** it sets if the first step can be used also during normal regulation.
NO = first step used only during the start phase
YES = first step used also during normal regulation

7.1.2 Regulation (C37-C44)

- C37 **Type of regulation for compressor circuit 1:** **db** = neutral zone, **Pb** = proportional band.
- C38 **Type of regulation for compressor circuit 2:** **db** = neutral zone, **Pb** = proportional band.
- C41 **Compressor rotation circuit 1:**
YES = rotation: the algorithm distributes the working time between loads to ensure even run times.
no = fixed sequence: the compressors are enabled and disabled in fixed sequence: first, second etc.
- C42 **Compressor rotation circuit 2:**
YES = rotation: the algorithm distributes the working time between loads to ensure even run times.
no = fixed sequence: the compressors are enabled and disabled in fixed sequence: first, second etc.
- C43 **Fan rotation circuit 1:**
YES = rotation: the algorithm distributes the working time between loads to ensure even run times.
no = fixed sequence: the fans are enabled and disabled in fixed sequence: first, second etc.
- C44 **Fan rotation circuit 2:**
YES = rotation: the algorithm distributes the working time between loads to ensure even run times.
no = fixed sequence: the fans are enabled and disabled in fixed sequence: first, second etc.

7.1.3 Display (C45-C46)

- C45 **Displaying measurement unit:** it sets the measurement unit used for the display and for parameters that are connected to temperature/pressure. In parenthesis other measurement unit.
CDEC: °C with decimal point (bar);
CINT: °C with decimal point (bar);
F: °F (PSI);
BAR: bar (°C);

PSI: PSI (°F);
 KPA: KPA (°C)
 CKPA: °C (KPA)

NOTE1: changing the measurement unit, the instrument will update parameter values that refer to pressure or temperature.

NOTE2: parameters with probe calibration, are reset during the measurement unit change.

- C46 Pressure display:** it indicates if the range of the probes are related to relative or absolute pressure.
REL = relative pressure; **AbS**: absolute pressure
NOTE: the temperature is updated changing this value.

7.1.4 Kind of gas for Circuit 2 (C47)

- C47 Kind of gas for circuit 2: set the kind of refrigerant used in the circuit 2**
 Setting the kind of gas, the XC1000D associate the pressure with the temperature.
 The following table show the refrigerant gases managed by XC1000D series, with their operating range

LABEL	REFRIGERANT	OPERATING RANGE
R22	r22	-50÷60°C/-58÷120°F
r134	r134A	-70÷60°C/-94÷120°F
r404A	r404A	-50÷60°C/-58÷120°F
r407A	r407A	-50÷60°C/-58÷120°F
r410	r410	-50÷60°C/-58÷120°F
r507	r507	-70÷60°C/-94÷120°F
r407C	r407C	-50÷60°C/-58÷120°F
r407F	r407F	-50÷60°C/-58÷120°F
r290	r290 – Propane	-50÷60°C/-58÷120°F
CO2	r744 - Co2	-50÷30°C/-58÷86°F
r450A	r450A	-45÷60°C/-69÷120°F
r513	r513	-45÷60°C/-69÷120°F
r448	r448A	-45÷60°C/-69÷120°F
r449	r449A	-45÷60°C/-69÷120°F
r32	r32	-55÷60°C/-94÷120°F
r1234ze	r1234ze	-18÷50°C/0÷122°F
717	717	-50÷60°C/-58÷120°F

*** NOTE: the refrigerant used in the circuit 1 has to be set by the parameter C34 ***

7.1.5 Analog Inputs (Ai1-Ai15)

- AI1 Kind of probe of P1 & P2:** it sets the kind of probes for suction sections: **Cur** = 4 ÷ 20 mA probe; **Ptc** = Ptc probe; **ntc** = NTC probe; **rAt** = ratiometric probe (0÷5V).
- AI2 Adjustment of read out for the probe 1 at 4mA/0V:** (-1.00 ÷ AI3 bar; -15 ÷ AI3 PSI, -100 ÷ AI3 KPA)
- AI3 Adjustment of read out for the probe 1 at 20mA/5V:** (AI2 ÷ 100.00 bar; AI2 ÷ 750 PSI; AI2 ÷ 10000 KPA)
- AI4 Probe 1 calibration:**
 with **C45 = CDEC or CINT:** -12.0 ÷ 12.0 °C
 with **C45= bar:** -1.20 ÷ 1.20 bar;
 with **C45 = F or PSI:** -120 ÷ 120 °F o PSI
 with **C45 = KPA:** -1200 ÷ 1200 KPA;
- AI5 Adjustment of read out for the probe 2 at 4mA/0V:** (-1.00 ÷ AI6bar; -15 ÷ AI6 PSI)
- AI6 Adjustment of read out for the probe 2 at 20mA/5V:** (AI5 ÷ 51.00 bar; AI5 ÷ 750 PSI)
- AI7 Probe 2 calibration:**
 with **C43 = CEL_DEC or CEL_INT:** -12.0 ÷ 12.0 °C
 with **C43 = bar:** -1.20 ÷ 1.20 bar;
 with **C43 = FAR or PSI:** -120 ÷ 120 °F or PSI

- AI8** **Kind of probe of P3 & P4:** : it sets the kind of probes for delivery sections: **Cur** = 4 ÷ 20 mA probe; **Ptc** = Ptc probe; **ntc** = NTC probe; **rAt** = rathimetric probe (0÷5V).
- AI9** **Adjustment of read out for the probe 3 at 4mA/0V:** (-1.00 ÷ AI10bar; -15 ÷ AI10 PSI; -100 ÷ AI10 KPA)
- AI10** **Adjustment of read out for the probe 3 at 20mA/5V:** (AI9 ÷ 100.00 bar; AI9 ÷ 750 PSI; AI9 ÷ 10000 KPA)
- AI11** **Probe 3 calibration**
 with **C45 = CDEC or CINT:** -12.0 ÷ 12.0 °C
 with **C45 = bar:** -1.20 ÷ 1.20 bar;
 with **C45 = F or PSI:** -120 ÷ 120 °F o PSI
 with **C45 = KPA:** -1200 ÷ 1200 KPA;
- AI12** **Adjustment of read out for the probe 4 at 4mA/0V:** (-1.00 ÷ AI13bar; -15 ÷ AI13 PSI; -100 ÷ AI13 KPA)
- AI13** **Adjustment of read out for the probe 4 at 20mA/5V:** (AI12 ÷ 100.00 bar; AI12 ÷ 750 PSI; AI12 ÷ 10000 KPA)
- AI14** **Probe 4 calibration:**
 with **C45 = CDEC or CINT:** -12.0 ÷ 12.0 °C
 with **C45 = bar:** -1.20 ÷ 1.20 bar;
 with **C45 = F or PSI:** -120 ÷ 120 °F o PSI
 with **C45 = KPA:** -1200 ÷ 1200 KPA;
- AI15** **Alarm activated in case of regulation faulty probe:**
nu = none relay; **ALr**: all the C(i) outputs set as ALr; **ALr1**: all the C(i) outputs set as ALr1, **ALr2**: all the C(i) outputs set as ALr2

7.1.6 Auxiliary analog inputs (Ai1-Ai15)

- AI16** **Probe 1 AUX setting:** **ptc** = PTC probe; **ntc**= NTC probe
- AI17** **Probe 1 AUX action type:** it sets the function of the AUX1 probe (term. 70-71)
nu = not used
Au1 = thermostat probe for AUX1 relay;
Au2 = thermostat probe for AUX2 relay;
Au3 = thermostat probe for AUX3 relay;
Au4 = thermostat probe for AUX4 relay;
otC1 = for the optimization of the delivery pressure/temperature, circuit 1 (dynamic set of delivery circuit 1);
otC2 = for the optimization of the delivery pressure/temperature, circuit 2 (dynamic set of delivery circuit 2);
otA1 = for the optimization of the suction pressure/temperature, (dynamic set point) circuit 1(dynamic set of suction circuit 1);
otA2 = for the optimization of the suction pressure/temperature, (dynamic set point) circuit 2 (dynamic set of suction circuit 2)
SH1 = to calculate superheat for suction 1
SH2 = to calculate superheat for suction 2
- AI18** **Probe 1 AUX calibration:** -12.0 ÷ 12.0 °C; -120 ÷ 120 °F
- AI19** **Probe 2 AUX setting:** **ptc** = PTC probe; **ntc**= NTC probe
- AI20** **Probe 2 AUX action type:** it sets the function of the AUX1 probe (term. 71-72)
nu = not used
Au1 = thermostat probe for AUX1 relay;
Au2 = thermostat probe for AUX2 relay;
Au3 = thermostat probe for AUX3 relay;
Au4 = thermostat probe for AUX4 relay;
otC1 = for the optimization of the delivery pressure/temperature, circuit 1 (dynamic set of delivery circuit 1);
otC2 = for the optimization of the delivery pressure/temperature, circuit 2 (dynamic set of delivery circuit 2);
otA1 = for the optimization of the suction pressure/temperature, (dynamic set point) circuit 1(dynamic set of suction circuit 1);
otA2 = for the optimization of the suction pressure/temperature, (dynamic set point) circuit 2 (dynamic set of suction circuit 2)
SH1 = to calculate superheat for suction 1
SH2 = to calculate superheat for suction 2
- AI21** **Probe 2 AUX calibration:** -12.0 ÷ 12.0 °C; -120 ÷ 120 °F

- AI22 Probe 3 AUX setting:** **ptc** = PTC probe; **ntc**= NTC probe
- AI23 Probe 3 AUX action type:** it sets the function of the AUX1 probe (term. 73-74)
nu = not used
Au1 = thermostat probe for AUX1 relay;
Au2 = thermostat probe for AUX2 relay;
Au3 = thermostat probe for AUX3 relay;
Au4 = thermostat probe for AUX4 relay;
otC1 = for the optimization of the delivery pressure/temperature, circuit 1 (dynamic set of delivery circuit 1);
otC2 = for the optimization of the delivery pressure/temperature, circuit 2 (dynamic set of delivery circuit 2);
otA1 = for the optimization of the suction pressure/temperature, (dynamic set point) circuit 1 (dynamic set of suction circuit 1);
otA2 = for the optimization of the suction pressure/temperature, (dynamic set point) circuit 2 (dynamic set of suction circuit 2)
SH1 = to calculate superheat for suction 1
SH2 = to calculate superheat for suction 2
- AI24 Probe 3 AUX calibration:** -12.0 ÷ 12.0 °C; -120 ÷ 120 °F
- AI25 Probe 4 AUX setting:** **ptc** = PTC probe; **ntc**= NTC probe
- AI26 Probe 4 AUX action type:** it sets the function of the AUX1 probe (term. 74-75)
nu = not used
Au1 = thermostat probe for AUX1 relay;
Au2 = thermostat probe for AUX2 relay;
Au3 = thermostat probe for AUX3 relay;
Au4 = thermostat probe for AUX4 relay;
otC1 = for the optimization of the delivery pressure/temperature, circuit 1 (dynamic set of delivery circuit 1);
otC2 = for the optimization of the delivery pressure/temperature, circuit 2 (dynamic set of delivery circuit 2);
otA1 = for the optimization of the suction pressure/temperature, (dynamic set point) circuit 1 (dynamic set of suction circuit 1);
otA2 = for the optimization of the suction pressure/temperature, (dynamic set point) circuit 2 (dynamic set of suction circuit 2)
SH1 = to calculate superheat for suction 1
SH2 = to calculate superheat for suction 2
- AI27 Probe 4 AUX calibration:** -12.0 ÷ 12.0 °C; -120 ÷ 120 °F
- AI28 Alarm relay on with auxiliary probe fault:**
nu = relay not present; **ALr**: all the C(i) outputs set as ALr; **ALr1**: all C(i) outputs set as ALr1, **ALr2**: all C(i) outputs set as ALr2.

7.1.7 Safety Digital Inputs (Di2-Di13)

- DI2 Low pressure switch polarity (term. 52 - 53) – circuit 1:**
oP=LP d.i. enabled by voltage absence;
cL= LP d.i. enabled by voltage presence.
- DI3 Low pressure switch polarity (term. 56 - 57) – circuit 2:**
oP=LP d.i. enabled by voltage absence;
cL= LP d.i. enabled by voltage presence.
- DI4 High pressure switch polarity (term. 54 - 55) – circuit 1:**
oP=HP d.i. enabled by voltage absence;
cL= HP d.i. enabled by voltage presence.
- DI5 High pressure switch polarity (term. 58 - 59) – circuit 2:**
oP=HP d.i. enabled by voltage absence;
cL= HP d.i. enabled by voltage presence.
- DI6 Relay activated in case of pressure switch alarm:**
nu = no relay activation, only visual signalling; **ALr**: all the C(i) outputs set as ALr; **ALr1**: all the C(i) outputs set as ALr1, **ALr2**: all the C(i) outputs set as ALr2
- DI7 Compressor alarm inputs polarity - circuit 1**
oP= d.i. enabled by voltage absence;
cL= d.i. enabled by voltage presence.
- DI8 Compressor alarm inputs polarity - circuit 2**
oP= d.i. enabled by voltage absence;

- DI9** cL= d.i. enabled by voltage presence.
Fan alarm inputs polarity - circuit 1
 oP= d.i. enabled by voltage absence;
 cL= d.i. enabled by voltage presence.
- DI10** **Fan alarm inputs polarity - circuit 2**
 oP= d.i. enabled by voltage absence;
 cL= d.i. enabled by voltage presence.
- DI11** **Manual reset of compressor alarms signalled by d.i.**
 no = automatic recover of alarm: regulation restart when the correspondent digital input is disabled
 yES = manual recover for the alarms of compressors
- DI12** **Manual reset of fan alarms signalled by d.i.**
 no = automatic recover of alarm: a fan restarts when the correspondent digital input is disabled
 yES = manual recover for the alarms of fan
- DI13** **Relay activated in case of compressor or fan alarms:**
 nu = no relay activation, only visual signalling; **Alr**: all the C(i) outputs set as ALr; **ALr1**: all the C(i) outputs set as ALr1, **ALr2**: all the C(i) outputs set as ALr2

7.1.8 Digital Inputs (Di14-Di27)

- DI14** **Polarity of configurable digital input 1 (term 36-37)**
 oP: the digital input is activated by opening the contact;
 CL: the digital input is activated by closing the contact.
- DI15** **Function of configur. configurable digital input 1 (term. 36-37)**
 ES1 = energy saving circuit 1
 ES2 = energy saving circuit 2
 OFF1 = circuit 1 stand –by
 OFF2 = circuit 2 stand –by
 LL1 = liquid level alarm for circuit 1
 LL2 = liquid level alarm for circuit 2
 noCRO = it disables the set point coming from the supervising system, and it restores SETC1 and SETC2 set.
 noSTD1 = it disables the dynamic set point on the circuit 1, and it restores SETC1 and SETF1 set.
 noSTD2 = it disables the dynamic set point on the circuit 2, and it restores SETC2 and SETF2 set.
- DI16** **Delay of configurable d.i. 1** (0 ÷ 255 min)
- DI17** **Polarity of configurable digital input 2 (term 38-39)**
 oP: the digital input is activated by opening the contact;
 CL: the digital input is activated by closing the contact.
- DI18** **Function of configur. configurable digital input 2 (term. 38-39)**
 ES1 = energy saving circuit 1
 ES2 = energy saving circuit 2
 OFF1 = circuit 1 stand –by
 OFF2 = circuit 2 stand –by
 LL1 = liquid level alarm for circuit 1
 LL2 = liquid level alarm for circuit 2
 noCRO = it disables the set point coming from the supervising system, and it restores SETC1 and SETC2 set.
 noSTD1 = it disables the dynamic set point on the circuit 1, and it restores SETC1 and SETF1 set.
 noSTD2 = it disables the dynamic set point on the circuit 2, and it restores SETC2 and SETF2 set.
- DI19** **Delay of configurable d.i. 2** (0 ÷ 255 min)
- DI20** **Polarity of configurable digital input 3 (term 40-41)**
 oP: the digital input is activated by opening the contact;
 CL: the digital input is activated by closing the contact.
- DI21** **Function of configur. configurable digital input 3 (term. 40-41)**
 ES1 = energy saving circuit 1
 ES2 = energy saving circuit 2
 OFF1 = circuit 1 stand –by
 OFF2 = circuit 2 stand –by
 LL1 = liquid level alarm for circuit 1
 LL2 = liquid level alarm for circuit 2
 noCRO = it disables the set point coming from the supervising system, and it restores SETC1 and SETC2 set.
 noSTD1 = it disables the dynamic set point on the circuit 1, and it restores SETC1 and SETF1 set.

- noSTD2** = it disables the dynamic set point on the circuit 2, and it restores SETC2 and SETF2 set.
- DI22** **Delay of configurable d.i. 3** (0 ÷ 255 min)
- DI23** **Polarity of configurable digital input 4 (term. 42-43)**
oP: the digital input is activated by opening the contact;
CL: the digital input is activated by closing the contact.
- DI24** **Function of configur. configurable digital input 4 (term. 42-43)**
ES1 = energy saving circuit 1
ES2 = energy saving circuit 2
OFF1 = circuit 1 stand –by
OFF2 = circuit 2 stand –by
LL1 = liquid level alarm for circuit 1
LL2 = liquid level alarm for circuit 2
noCRO = it disables the set point coming from the supervising system, and it restores SETC1 and SETC2 set.
noSTD1 = it disables the dynamic set point on the circuit 1, and it restores SETC1 and SETF1 set.
noSTD2 = it disables the dynamic set point on the circuit 2, and it restores SETC2 and SETF2 set.
- DI25** **Delay of configurable d.i. 4** (0 ÷ 255 min)
- DI26** **Relay activated in case of liquid level alarm – circuit 1**
nu = no relay activation, only visual signalling; **ALr:** all the C(i) outputs set as ALr; **ALr1:** all the C(i) outputs set as ALr1, **ALr2:** all the C(i) outputs set as ALr2
- DI27** **Relay activated in case of liquid level alarm – circuit 2**
nu = no relay activation, only visual signalling; **ALr:** all the C(i) outputs set as ALr; **ALr1:** all the C(i) outputs set as ALr1, **ALr2:** all the C(i) outputs set as ALr2

7.1.9 Compressor Action (CPI-CP8)

- CP1** **Regulation band width for compressors- circuit 1** (0.10÷10.00 bar; 0.1÷25.0°C, 1÷80PSI, 1÷50°F; 10÷1000 KPA) The band is symmetrical compared to the target set point, with extremes: SETC1+(CP1)/2 ... SETC1-(CP1)/2. The measurement unit depends on the C45 par.
NOTE: If the circuit 1 has 1 relay set as a frequency compressor (Frq1), the 1Q19 parameter is used instead of the CP1 parameter: regulation band width that is added to the set point 1.
- CP2** **Minimum compressor set point - circuit 1** (AI2 ÷ SETC1 bar, PSI or KPA; -50.0 ÷ SETC1 °C; -58.0 ÷ SETC1 °F). The measurement unit depends on C45 parameter. It sets the minimum value that can be used for the compressor set point, to prevent the end user from setting incorrect values.
- CP3** **Maximum compressor set point - circuit 1** (SETC1÷AI3 bar/PSI/KPA; SETC1÷150.0°C; SETC1÷302°F)
The measurement unit depends on C45 parameter. It sets the maximum acceptable value for compressor set point.
- CP4** **Compressor energy saving value - circuit 1** (-20.00÷20.00bar; -50.0÷50.0 °C; -300÷300 PSI; -90÷90 °F; -2000÷2000KPA) this value is add to the compressor set point when the energy saving is enabled.
- CP5** **Regulation band width for compressors - circuit 2** (0.10÷10.00 bar; 0.1÷25.0°C, 1÷80PSI, 1÷50°F; 10÷1000 KPA). The band is symmetrical compared to the target set point, with extremes: SETC2+(CP5)/2 ... SETC2-(CP1)/2. The measurement unit depends on the C43 par.
NOTE: If the circuit 1 has 1 relay set as a frequency compressor (Frq2), the 2Q18 parameter is used instead of the CP5 parameter: regulation band width that is added to the set point 2.
- CP6** **Minimum compressor set point - circuit 2** (AI5 ÷ SETC2 bar or PSI o KPA; -50.0 ÷ SETC2 °C; -58.0 ÷ SETC2 °F). The measurement unit depends on C45 parameter. It sets the minimum value that can be used for the compressor set point, to prevent the end user from setting incorrect values.
- CP7** **Maximum compressor set point - circuit 2** (SETC2÷AI6 bar/PSI/KPA; SETC2÷150.0°C; SETC2÷302°F)
The measurement unit depends on C45 parameter. It sets the maximum acceptable value for compressor set point.
- CP8** **Compressor energy saving value - circuit 2** (-20.00÷20.00bar; -50.0÷50.0 °C; -300÷300 PSI; -90÷90 °F) this value is add to the compressor set point when the energy saving is enabled.

7.1.10 Safety Compressors (CP9-CP19)

- CP9** **Minimum time between 2 following switching ON of the same compressor** (0÷255 min).
- CP10** **Minimum time between the switching off of a compressor and the following switching on.** (0÷255min).

Note: usually CP9 is greater than CP10

- CP11** Time delay between the insertion of two different compressors (0 ÷ 99.5 min; res. 1sec)
CP12 Time delay between switching off of two different compressors (0 ÷ 99.5 min; res. 1sec)
CP13 Minimum time load on (0 ÷ 99.5 min; res. 1sec)
CP14 Maximum time load on (0 ÷ 24 h; with 0 this function is disabled.) If a compressor keeps staying on for the CP14 time, it's switched off and it can restart after the CP10 standard time or after the CP15 time with frequency compressor (Frq1 or Frq2).
CP15 Minimum time a frequency compressor (CP1..CP15 =Frq1 or Frq2) stays off after CP14 time (0÷255 min)
CP16 CP11 delay enabled also for the first call. If enabled, the triggering of the step is delayed for a "CP11" time, respect to the call.
no = "CP11" not enabled;
yES="CP11" enabled
CP17 CP12 delay enabled also for the first off. If enabled, the triggering of the step is delayed for a "CP12" time, respect to the call.
no = "CP12" not enabled;
yES="CP12" enabled
CP18 Output delay at power on (0 ÷ 255 sec)
CP19 Booster function enabled:
no = compressors of 2 circuits work independently
yES = if at least one compressor of the circuit 1 (BT) is ON, also one compressor of the circuit 2 (TN) is enabled, independently from the pressure of the circuit 2. This ensures that the gas coming from the circuit 1 is sucked by the compressors of the circuit 2.

7.1.11 Fan Action (F1-F8)

- F1** Regulation band width for fans – circuit 1 (0.10÷10.00 bar; 0.1÷30.0°C, 1÷80PSI, 1÷50°F; 10÷1000 KPA) **Set the C45 par. and the target set point for fans before setting this parameter.**
The band is symmetrical compared to the fan target set point, with extremes: SETF1-(F1)/2 ... SETF1+(F1)/2. The measurement unit depends on the C45 par.
F2 Minimum fan set point – circuit 1 BAR: 2 (AI9 ÷ SETF1 bar or PSI or KPA; -50.0 ÷ SETF1 °C; -58.0 ÷ SETF1 °F). The measurement unit depends on C45 parameter. It sets the minimum value that can be used for the fan set point, to prevent the end user from setting incorrect values.
F3 Maximum fan set point - circuit 1 (SETF1÷AI10 bar/PSI/KPA; SETF1÷150.0°C; SETF1÷302°F)
The measurement unit depends on C45 parameter. It sets the maximum acceptable value for fan set point.
F4 Fan energy saving value - circuit 1 (-20.00÷20.00bar; -50.0÷50.0 °C; -300÷300 PSI; -90÷90 °F; -2000÷2000KPA) this value is added to the fan set point when the energy saving is enabled.
F5 Regulation band width for fans – circuit 2 (0.10÷10.00 bar; 0.1÷30.0°C, 1÷80PSI, 1÷50°F; 10÷1000 KPA)
Set the C45 par. and the target set point for fans before setting this parameter.
The band is symmetrical compared to the fan target set point, with extremes: SETF2-(F5)/2 ... SETF2+(F5)/2. The measurement unit depends on the C45 par.
F6 Minimum fan set point – circuit 2 BAR: 2 (AI12 ÷ SETF2 bar or PSI or KPA; -50.0 ÷ SETF2 °C; -58.0 ÷ SETF2 °F). The measurement unit depends on C45 parameter. It sets the minimum value that can be used for the fan set point, to prevent the end user from setting incorrect values.
F7 Maximum fan set point - circuit 2 (SETF2÷AI13 bar/PSI/KPA; SETF2÷150.0°C; SETF2÷302°F)
The measurement unit depends on C45 parameter. It sets the maximum acceptable value for fan set point.
F8 Fan energy saving value - circuit 2 (-20.00÷20.00bar; -50.0÷50.0 °C; -300÷300 PSI; -90÷90 °F; -2000÷2000KPA) this value is added to the fan set point when the energy saving is enabled.

7.1.12 Safety Fans (F9-F10)

- F9** Time delay between the insertion of two different fans (1 ÷ 255 sec)
F10 Time delay between switching off of two different fans (1 ÷ 255 sec)

7.1.13 Energy Saving Management (HS1-HS14)

- HS1** Energy Saving start time on Monday (0:0÷23.5h; nu)
HS2 Monday Energy Saving duration (0:0÷23.5h)
HS3 Energy Saving start time on Tuesday (0:0÷23.5h; nu)

HS4	Tuesday Energy Saving duration (0:0÷23.5h)
HS5	Energy Saving start time on Wednesday (0:0÷23.5h; nu)
HS6	Wednesday Energy Saving duration (0:0÷23.5h)
HS7	Energy Saving start time on Thursday (0:0÷23.5h; nu)
HS8	Thursday Energy Saving duration (0:0÷23.5h)
HS9	Energy Saving start time on Friday (0:0÷23.5h; nu)
HS10	Friday Energy Saving duration (0:0÷23.5h)
HS11	Energy Saving start time on Saturday (0:0÷23.5h; nu)
HS12	Saturday Energy Saving duration (0:0÷23.5h)
HS13	Energy Saving start time on Sunday (0:0÷23.5h; nu)
HS14	Sunday Energy Saving duration (0:0÷23.5h)

7.1.14 Configuring the temperature/pressure alarms (AC0-AF0)

AC0 Relative/absolute compressor alarms

REL = pressure/temperature alarms associated with the setpoint. In this case, the alarm threshold is added/deducted from the respective setpoint.

E.g. suction high temperature alarm 1. The alarm threshold is SETC1+ AC4.

ABS = alarms with absolute pressure/temperature values. In this case the alarm threshold is determined by the alarm parameter value.

E.g. high temperature alarm for suction 1. The alarm threshold is AC4

AF0 Relative/absolute fan alarms

REL = pressure/temperature alarms associated with the setpoint. In this case, the alarm threshold is added/deducted from the respective setpoint.

E.g. condensation high temperature alarm 1. The alarm threshold is SETF1+ AF2

ABS = alarms with absolute pressure/temperature values. In this case the alarm threshold is determined by the alarm parameter value.

E.g. condensation high temperature alarm 1. The alarm threshold is AF2

7.1.15 Compressor Alarms (AC1-AC19)

AC1 Probe 1 alarm exclusion at power on (0 ÷ 255 min) it is the period starting from instrument switch on, before an alarm probe is signalled. During this time if the pressure is out of range all the compressor are switched on.

AC2 Probe 2 alarm exclusion at power on (0 ÷ 255 min) it is the period starting from instrument switch on, before an alarm probe is signalled. During this time if the pressure is out of range all the compressor are switched on.

AC3 Low pressure (temperature) alarm for compressors – circuit 1: (0.10 ÷ 30.00bar; 0.0 ÷ 100.0°C; 1÷430 PSI; 1÷200.0°F; 10 ÷ 3000KPA)

With AC0 = ABS: -1.00 to AC4bar; -50 to AC4°C; -14 to AC4 PSI; -58 to AC4°F; -100 to AC4 KPA)
The measurement unit depends on C45 parameter.

With AC0 = REL If the pressure (temperature) falls below the “SETC1-AC3” value, the “Low alarm – Suction 1” is activated at the end of the AC5 period of time.

With AC0 = ABS If the pressure (temperature) falls below the “AC3” value, the “Low alarm – Suction 1” is activated at the end of the AC5 period of time.

AC4 High pressure (temperature) alarm for compressors – circuit 1: (With AC0 = REL 0.10 to 30.00bar; 0.0 to 100.0°C; 1 to 430 PSI; 1 to 200.0°F; 10 to 3000KPA

With AC0 = ABS: AC3 to 100.00bar; AC3 to 150°C; -AC3 to 1450 PSI; AC3 to 230°F; AC3 to 10000 KPA).

The measurement unit depends on C45 parameter.

With AC0 = REL If the pressure (temperature) exceeds the “SETC1+AC4” value, the “High alarm – Suction 1” is activated at the end of the AC5 period of time.

With AC0 = ABS If the pressure (temperature) exceeds the “AC4” value, the “High alarm – Suction 1” is activated at the end of the AC5 period of time.

AC5 Low and High compressor pressure (temperature) alarms delay – circuit 1 (0÷255 min) time interval between the detection of a pressure (temperature) alarm condition and alarm signalling.

AC6 Low pressure (temperature) alarm for compressors – circuit 2:

(With AC0 = REL: 0.10 to 30.00bar; 0.0 to 100.0°C; 1to 430 PSI; 1to 200.0°F; 10 to 3000KPA

With AC0 = ABS: -1.00 to AC7bar; -50 to AC7°C; -14 to AC7 PSI; -58 to AC7°F; -100 to AC7 KPA)
The measurement unit depends on C45 parameter.

With AC0 = REL If the pressure (temperature) falls below the “SETC2-AC6” value, the “Low alarm – Suction 2” is activated at the end of the AC8 period of time.

- With **AC0 = ABS** If the pressure (temperature) falls below the “AC6” value, the “Low alarm – Suction 2” is activated at the end of the AC8 period of time.
- AC7 High pressure (temperature) alarm for compressors – circuit 2: (With AC0 = REL 0.10 to 30.00bar; 0.0 to 100.0°C; 1 to 430 PSI; 1 to 200.0°F; 10 to 3000KPA**
With AC0 = ABS: AC6 to 100.00bar; AC6 to 150°C; -AC6 to 1450 PSI; AC6 to 230°F; AC6 to 10000 KPA). The measurement unit depends on C45 parameter.
With AC0 = REL If the pressure (temperature) exceeds the “SETC2+AC7” value, the “High alarm – Suction 2” is activated at the end of the AC8 period of time.
With AC0 = ABS If the pressure (temperature) exceeds the “AC7” value, the “High alarm – Suction 2” is activated at the end of the AC8 period of time.
- AC8 Low and High compressor pressure (temperature) alarms delay – circuit 2 (0÷255 min)** time interval between the detection of a pressure (temperature) alarm condition and alarm signalling.
- AC9 Relay activated in case of pressure (temperature) alarm**
nu = no relay activation, only visual signalling; **Alr:** all the C(i) outputs set as ALR; **ALR1:** all the C(i) outputs set as ALR1, **ALR2:** all the C(i) outputs set as ALR2
- AC10 Service request:** (0÷25000h with 0 the function is disabled) number of running hours after that maintenance warning is generated
- AC11 Relay activated in case of service request alarm**
nu = no relay activation, only visual signalling; **Alr:** all the C(i) outputs set as ALR; **ALR1:** all the C(i) outputs set as ALR1, **ALR2:** all the C(i) outputs set as ALR2
- AC12 Low pressure-switch intervention numbers – circuit 1: (0÷15).** Every time the pressure-switch is activated all the compressors of the circuit 1 are turned off. If the low pressure-switch is activated AC12 times in the AC13 interval, the compressors of the first circuit are switched off and only the manually unlocking is possible.
- AC13 Pressure-switch interventions time (0÷255 min) – circuit 1** Interval, linked to the AC12 parameter, for counting interventions of the low pressure-switch.
- AC14 Number of steps engaged with suction probe 1 faulty (0 ÷ 15)**
- AC15 Not used**
- AC16 Low pressure-switch intervention numbers – circuit 2: (0÷15).** Every time the pressure-switch is activated all the compressors of the circuit 2 are turned off. If the low pressure-switch is activated AC16 times in the AC17 interval, the compressors of the second circuit are switched off and only the manually unlocking is possible.
- AC17 Pressure-switch interventions time (0÷255 min) – circuit 2** Interval, linked to the AC16 parameter, for counting interventions of the low pressure-switch.
- AC18 Number of steps engaged with suction probe 2 faulty (0 ÷ 15)**
- AC20 Electronic pressure switch activation for circuit 1**
NO = electronic pressure switch not enabled
YES = electronic pressure switch enabled
- AC21 Pressure/temperature threshold of compressor set for circuit 1**
(Ai2 - SETC1 for pressure probe; -40°C/°F - SETC1 for temperature probe).
- AC22 Enabling the electronic pressure switch for circuit 2**
NO = electronic pressure switch not enabled
YES = electronic pressure switch enabled
- AC23 Pressure/temperature threshold of compressor set for circuit 2**
(Ai5 - SETC2 for pressure probe; -40°C/°F - SETC2 for temperature probe).

7.1.16 Fan Alarms (AF1-AF17)

- AF1 Low pressure (temperature) alarm for fans – circuit 1: (With AF0 = REL: 0.10 ÷ 30.00bar; 0.0 ÷ 100.0°C; 1÷430 PSI; 1÷200.0°F; 10 ÷ 3000KPA**
With AF0 = ABS: -1.00 to AF2bar; -50 to AF2°C; -14to AF2PSI; -58to AF2°F; -100 to AF2KPA)
The measurement unit depends on C45 parameter.
With AF0 = REL If the pressure (temperature) falls below the “SETF1-AF1” value, the “Low alarm – Condensation 1” is activated at the end of the AF3 period of time.
With AF0 = ABS If the pressure (temperature) falls below the “AF1” value, the “Low alarm – Condensation 1” is activated at the end of the AF3 period of time”.
- AF2 High pressure (temperature) alarm for fans– circuit 1: (With AF0 = REL 0.10 to 30.00bar; 0.0 to 100.0°C; 1 to 430 PSI; 1 to 200.0°F; 10 to 3000KPA**
With AF0 = ABS: AF1 to 100.00bar; AF1to150°C; AF1to1450 PSI; AF1to230°F; AF1to10000 KPA).
The measurement unit depends on C45 parameter.
With AF0 = REL If the pressure (temperature) exceeds the “SETF1+AF2” value, the “High alarm – Condensation 1” is activated at the end of the AF3 period of time

- With **AC0 = ABS** If the pressure (temperature) exceeds the "AF2" value, the "High alarm – Condensation 1" is activated at the end of the AF3 period of time
- AF3 Low and High fan pressure (temperature) alarms delay – circuit 1** (0÷255 min) time interval between the detection of a pressure (temperature) alarm condition and alarm signalling.
- AF4 Compressors off with pressure (temperature) alarm for fans– circuit 1**
no = compressors are not influenced by this alarm
yES = compressors are turned off in case of high pressure (temperature) alarm of fans
- AF5 Interval between 2 compressors turning off in case of high pressure (temperature) alarm for fans – circuit 1** (0 ÷ 255 min)
- AF6 High pressure-switch intervention numbers – circuit 1: (0÷15).** Every time the pressure-switch is activated all the compressors of the circuit 1 are turned off and the fan turned on. If the high pressure-switch is activated AF6 times in the AF7 interval, the compressors of the first circuit are switched off and the fans on, only the manually unlocking is possible.
- AF7 High pressure-switch interventions time (0÷255 min) – circuit 1** Interval, linked to the AF6 parameter, for counting interventions of the high pressure-switch.
- AF8 Fans on with delivery probe faulty – circuit 1** (0 ÷ 15)
- AF9 Low pressure (temperature) alarm for fans – circuit 2:**
(With AF0 = REL: 0.10 ÷ 30.00bar; 0.0 ÷ 100.0°C; 1÷430 PSI; 1÷200.0°F; 10 ÷ 3000KPA
With AF0 = ABS: -1.00 to AF10bar; -50 to AF10°C; -14to AF10 PSI; -58to AF10°F; -100 to AF10KPA)
The measurement unit depends on C45 parameter.
With AF0 = REL If the pressure (temperature) falls below the "SETF2-AF9" value, the "Low alarm – Condensation 2" is activated at the end of the AF11 period of time.
With AF0 = ABS If the pressure (temperature) falls below the "AF9" value, the "Low alarm – Condensation 2" is activated at the end of the AF11 period of time.
- AF10 High pressure (temperature) alarm for fans– circuit 2:**
(With AF0 = REL 0.10 to 30.00bar; 0.0 to 100.0°C; 1 to 430 PSI; 1 to 200.0°F; 10 to 3000KPA
With AF0 = ABS: AF9 to 100.00bar; AF9to150°C; AF9to1450 PSI; AF9to230°F; AF9to10000 KPA).
The measurement unit depends on C45 parameter.
With AF0 = REL If the pressure (temperature) exceeds the "SETF2+AF10" value, the "Low alarm – Condensation 2" is activated at the end of the AF11 period of time.
With AC0 = ABS If the pressure (temperature) exceeds the "AF10" value, the "Low alarm – Condensation 2" is activated at the end of the AF11 period of time.
- AF11 Low and High fan pressure (temperature) alarms delay – circuit 2** (0÷255 min) time interval between the detection of a pressure (temperature) alarm condition and alarm signalling.
- AF12 Compressors off with pressure (temperature) alarm for fans– circuit 2**
no = compressors are not influenced by this alarm
yES = compressors are turned off in case of high pressure (temperature) alarm of fans
- AF13 Interval between 2 compressors turning off in case of high pressure (temperature) alarm for fans – circuit 2** (0 to 255 sec)
- AF14 High pressure-switch intervention numbers – circuit 2: (0÷15).** Every time the pressure-switch is activated all the compressors of the circuit 2 are turned off and the fans turned on. If the high pressure-switch is activated AF14 times in the AF15 interval, the compressors of the second circuit are switched off and the fans on, only the manually unlocking is possible.
- AF15 High pressure-switch interventions time (0÷255 min) – circuit 2** Interval, linked to the AF14 parameter, for counting interventions of the high pressure-switch.
- AF16 Fans on with delivery probe faulty – circuit 2**(0 ÷ 15)
- AF17 Relay activated in case of pressure (temperature) alarms of fans**
nu = no relay activation, only visual signalling; **ALr:** all the C(i) outputs set as ALr; **ALr1:** all the C(i) outputs set as ALr1, **ALr2:** all the C(i) outputs set as ALr2

7.1.17 Dynamic Setpoint Suction (o1-o8)

- O1 Dynamic compressor set point function enabled - circuit 1**
no = standard regulation
yES = the SETC1 varies according to the setting of O2, O3, O4.
WARNING the dynamic set point requires a dedicated probe, so it's necessary one of the aux probes is set for this function in other words A17 or A120 or A123 or A127 has to be set as o1A1.
NOTE: if more than one probe is used for the optimization of the suction set point, only the higher temperature is considered.

- O2 Maximum compressor set point - circuit 1** (SETC1÷CP3) It sets the maximum value of compressor set point used in the dynamic set point function. The measurement unit depends on C45 parameter.
- O3 External temperature for maximum set point O2- circuit 1** (-40÷O4 °C /-40÷O4°F) It's the temperature detected by the external AUX probe, at which the maximum set point is reached.
- O4 External temperature for standard set point- circuit 1** (O3÷150°C O3÷302°F)
 1. with AUX temper. < O3 ==> "Real SETC1" = O2
 2. with AUX temper. > O4 ==> "Real SETC1" = SETC1
 3. with O3 < AUX temper < O4 ==> SETC1 < "Real SETC1" < O2

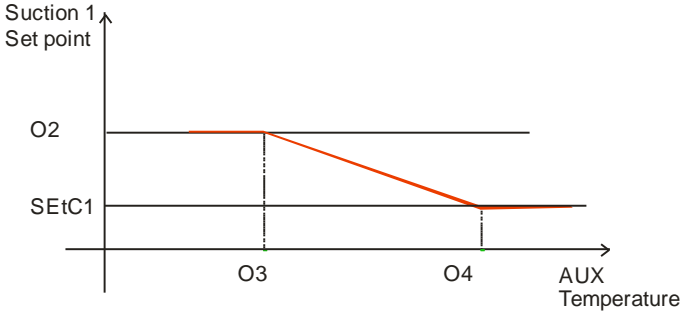

- O5 Dynamic compressor set point function enabled - circuit 2**
no = standard regulation
yES = the SETC2 varies according to the setting of O6, O7, O8.
WARNING the dynamic set point requires a dedicated probe, so it's necessary one of the aux probes is set for this function in other words AI17 or AI20 or AI23 or AI27 has to be set as otA2.
NOTE: if more than one probe is used for the optimization of the suction set point, only the higher temperature is considered.
- O6 Maximum compressor set point - circuit 2** (SETC2÷CP7) It sets the maximum value of compressor set point used in the dynamic set point function. The measurement unit depends on C45 parameter.
- O7 External temperature for maximum set point O6 - circuit 1** (-40÷O8 °C /-40÷O8°F) It's the temperature detected by the external AUX probe, at which the maximum set point is reached.
- O8 External temperature for standard set point- circuit 2** (O7÷150°C O7÷302°F)
 1. with AUX temper. < O7 ==> "Real SETC2" = O6
 2. with AUX temper. > O8 ==> "Real SETC2" = SETC2
 3. with O7 < AUX temper < O8 ==> SETC2 < "Real SETC2" < O6

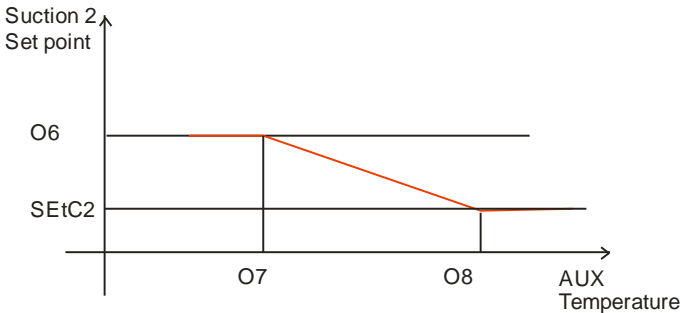

7.1.18 Dynamic Setpoint Condenser (o9-o14)

- O9 Dynamic set enabled for condenser- circuit 1**
no = standard regulation
yES = the SETF1 varies according to the setting of O10, O11.

WARNING the dynamic set point requires a dedicated probe, so it's necessary one of the aux probes is set for this function in other words AI17 or AI20 or AI23 or AI27 has to be set as otC1

O10 Minimum condenser set point - circuit 1 (F2÷SETF1)

O11 Differential for condenser dynamic set point –circuit 1 (-50.0÷50.0°C; -90÷90°F). The way of working of this algorithm is explained in the following exemplum.

Example

With the external temperature (otc1) > SETF1-O11 ==> "real SetF1" = SETF1

With the external temperature (otc1) < O10-O11 ==> "real SetF1"= O10

With O10-O11 < external temperature (otc1) < SETF1-O11 ==> O10 <"real SetF1"< SETF1

where

external temperature (otc1) is the temperature detected by the auxiliary probe set as otC1

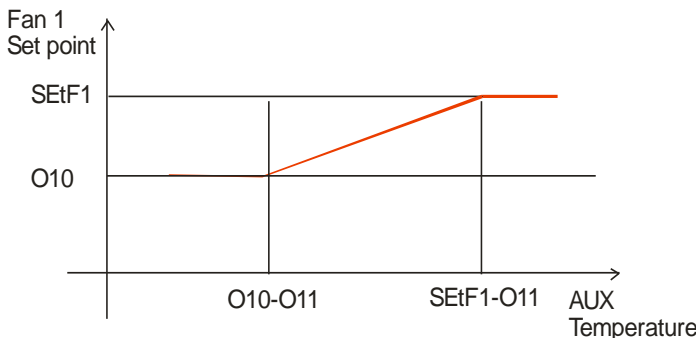

NOTE: if C45 = bar or PSI or KPA, O10 is bar or PSI, the XC1000D makes the changes required

O12 Dynamic set enabled for condenser- circuit 2

no = standard regulation

YES = the SETF2 varies according to the setting of O13, O14.

WARNING the dynamic set point requires a dedicated probe, so it's necessary one of the aux probes is set for this function in other words AI17 or AI20 or AI23 or AI27 has to be set as otC2.

O13 Minimum condenser set point - circuit 2 (F6÷SETF2)

O14 Differential for condenser dynamic set point –circuit 2 (-50.0÷50.0°C; -90÷90°F). The way of working of this algorithm is explained in the following exemplum.

Example

With the external temperature (otc2) > SETF2-O14 ==> "real SetF2" = SETF2

With the external temperature (otc2) < O13-O14 ==> "real SetF1"= O13

With O13-O14 < external temperature (otc1) < SETF2-O14 ==> O13 <"real SetF2"< SetF2

where

external temperature (otc2) is the temperature detected by the auxiliary probe set as otC2

7.1.19 Analog Outputs Configuration (1Q1-3Q1)

1Q1 Analog outputs 1-2 setting: (4÷20 mA - 0÷10 V): It set the kind of output for the first 2 analogue outputs (term. 33-34-35).

3Q1 Analog outputs 3-4 setting: (4÷20 mA - 0÷10 V): It set the kind of output for the first 2 analogue outputs (term. 30-31-32).

7.1.20 Analog output 1 (1Q2-1Q26)

1Q2 Analog output 1 function (term. 34-35)

FREE = pure analogue output

CPR = output for frequency compressor – circuit 1

CPR2 = output for frequency compressor – circuit 2

FAN = output for inverter fans – circuit 1 (only some fans driven by inverter, others enabled by on/off);

FAN2 = output for inverter fans – circuit 2 (only some fans driven by inverter, others enabled by on/off);

INVF1 = not used

INVF2 = not used

nu = not used

- 1Q3 Reference probe for analogue output 1**, it's used only when 1Q2 = FREE
Pbc1= Suction Probe, circuit 1 (term. 62-63 or 62 -68)
Pbc2= Suction Probe, circuit 2 (term. 64-63 or 64 -68)
- 1Q4 Adjustment of read out for the analog output 1** (-1.00÷100.00 bar; -15÷750PSI; -50÷150°C; -58÷302°F; -100÷10000 KPA). It's used only when 1Q2 = FREE
- 1Q5 Adjustment of read out for the analog output 1 at 20mA/10V** (-1.00÷100.00 bar; -15÷750PSI; -50÷150°C; -58÷302°F; -100÷10000 KPA). It's used only when 1Q2 = FREE
- 1Q6 Minimum value for analogue output 1** (0 ÷ 100%)
- 1Q7 Analog output 1 value after compressor start** (1Q6 ÷ 100 %) It's the value of the analogue output after a compressor has started, when the pressure/temperature is above the regulation band. – *Used during inverter regulation*
- 1Q8 Analog output 1 value after a compressor is switched off** (1Q6 ÷ 100 %) It's the value of the analogue output when a compressor has been switched off and the the pressure/temperature is below the regulation band. – *Used during inverter regulation*
- 1Q9 Exclusion band start value for analog output 1** (1Q6 ÷ 100 %): it allows to exclude a range of frequencies that could create problems to the compressor. – *Used during inverter regulation*
- 1Q10 Exclusion band end value for analog output 1** (1Q9 ÷ 100 %) – *Used during inverter regulation*
- 1Q11 Safety value for analog output 1** (0 ÷ 100 %): it's used in case of probe faulty.
- 1Q12 Delay between the entrance in the regulation band and the regulation activation** (0 ÷ 255sec): it's the delay between the entrance in the regulation band of pressure/temperature and the regulation start. Used to avoid false inverter starts dued to pressure variations. – *Used during inverter regulation.*
- 1Q13 Analog output 1 rise time** (0 ÷ 255 sec). It's the time necessary to the analog output to pass from the 1Q6 to 100%, when a compressor has started and the pressure/temperature is above the regulation band. – *Used during inverter regulation.*
- 1Q14 Analog output 1 permanency at 100% before load activation** (0 ÷ 255 sec): the analog output remains at 100% value for this time before a load is activated. – *Used during inverter regulation*
- 1Q15 Delay between pressure (temperature) goes down the set point and start of analog output 1 decreasing** (0÷255sec). – *Used during inverter regulation*
- 1Q16 Analog output 1 decreasing time** (0 ÷ 255sec) It's the time taken from the analog output to pass from the 100% to the 1Q6 value. It's used during the switching off phase, when the pressure is lower than the set point.
- 1Q17 Analog output 1 permanency at 1Q6 before a load is switched off** (0 ÷ 255sec) When the pressure (temperature) is below the set point, the analog output remains at 1Q6 value for the 1Q17 before a load is switched off.
- 1Q18 Analog output 1 decreasing time when a load is switched on** (0 ÷ 255sec) It's the time necessary to the analog output to pass from 100% to 1Q7 when a load is switched on.
- 1Q19 Regulation band** (0.10÷25.00bar; 0.0÷25.0°C; 1÷250 PSI; 1÷250°F;10÷2500 KPA). It is the band with the proportional action. It replaces CP1 for the inverter regulation. It is add to the set point. The proportional action starts when the temperature/pressure value is higher than the set point and it reaches the 100% when the pressure/temperature is equal or higher than set + 1Q19.
- 1Q20 Integral time** (0÷999s; with 0 integral action excluded). It sets the pound of the proportional action. The higher is 1Q20, the lower is the integral action support.
- 1Q21 Band offset** (-12.0÷12.0°C -12.00 ÷ 12.00BAR, -120÷120°F, -120÷120PSI; -1200÷1200KPA). Used to move the regulation band across to the set point.
- 1Q22 Integral action limitation** (0.0÷99.0 °C; 0÷180°F; 0.00÷50,00bar; 0÷725PSI; 0÷5000kPA) to stop the increasing of integral action when the pressure reaches the SET + 1Q22 value.
- 1Q24 Minimum inverter capacity with poor lubrication** (0÷99%; with 0 function excluded) If the frequency compressor works for the 1Q25 time with a frequency (in percentage) equal or lower than 1Q24, it is forced to work at 100% for the 1Q26 time in order to make the right lubrication.
- 1Q25 Maximum inverter functioning time at a lower frequency than 1Q24, before working at 100%** (1÷255min)
- 1Q26 Time of inverter functioning at 100% to restore the right lubrication** (1÷255min)

7.1.21 Analog output 2 (2Q1-2Q25)

- 2Q1** **Analog output 2 function** (term. 33-34)
FREE = pure analogue output
CPR = output for inverter frequency compressor – circuit 1
CPR2 = output for inverter frequency compressor – circuit 2
FAN = output for inverter fans– circuit 1 (only some fans driven by inverter, others enabled by on/off);
FAN2 = output for inverter fans – circuit 2 (only some fans driven by inverter, others enabled by on/off);
INVF1 = not used
INVF2 = not used
nu = not used
- 2Q2** **Reference probe for analogue output 2**, it's used only when 2Q1 = FREE
Pbc1= Suction Probe, circuit 1 (term. 62-63 or 62 -68)
Pbc2= Suction Probe, circuit 2 (term. 64-63 or 64 -68)
- 2Q3** **Adjustment of read out for the analog output 2 at 4mA/0V** (-1.00÷100.00 bar; -15÷750PSI; -50÷150°C; -58÷302°F; -100÷10000 KPA). It's used only when 2Q1 = FREE
- 2Q4** **Adjustment of read out for the analog output 2 at 20mA/10V** (-1.00÷100.00 bar; -15÷750PSI; -50÷150°C; -58÷302°F; -100÷10000 KPA). It's used only when 2Q1 = FREE
- 2Q5** **Minimum value for analogue output 2** (0 ÷ 100%)
- 2Q6** **Analog output 2 value after compressor start** (2Q5 ÷ 100 %) It's the value of the analogue output after a compressor has started, when the pressure/temperature is above the regulation band. – *Used during inverter regulation*
- 2Q7** **Analog output 2 value after compressor is switched off** (2Q5 ÷ 100 %) It's the value of the analogue output when a compressor has been switched off and the the pressure/temperature is below the regulation band. – *Used during inverter regulation*
- 2Q8** **Exclusion band start value for analog output 2** (2Q5 ÷ 100 %); it allows to exclude a range of frequencies that could create problems to the compressor. – *Used during inverter regulation*
- 2Q9** **Exclusion band end value for analog output 2** (2Q8 ÷ 100 %)- *Used during inverter regulation*
- 2Q10** **Safety value for analog output 2** (0 ÷ 100 %): it's used in case of probe faulty.
- 2Q11** **Delay between the entrance in the regulation band and the regulation activation** (0 ÷ 255sec): it's the delay between the entrance in the regulation band of pressure/temperature and the regulation start. Used to avoid false inverter starts due to pressure variations. – *Used during inverter regulation.*
- 2Q12** **Analog output 2 rise time** (0 ÷ 255 sec) It's the time necessary to the analog output to pass from the 1Q6 to 100%, when a compressor has started and the pressure/temperature is above the regulation band. – *Used during inverter regulation.*
- 2Q13** **Analog output 2 permanency before load activation** (0 ÷ 255 sec): the analog output remains at 100% value for this time before a load is activated. - *Used during inverter regulation*
- 2Q14** **Delay between pressure (temperature) goes down the set point and start of analog output 2 decreasing** (0÷255sec). – *Used during inverter regulation*
- 2Q15** **Analog output decreasing time** (0 ÷ 255sec) It's the time taken from the analog output to pass from the 100% when the pressure/temperature is equal or higher than set + 2Q18.
- 2Q16** **Analog output 2 permanency at 2Q5 value before a load is switched off** (0 ÷ 255sec) When the pressure (temperature) is below the set point, the analog output 2 remains at 2Q5 value before a load is switched off.
- 2Q17** **Analog output 2 decreasing time when a load is switched on** (0 ÷ 255sec) It's the time necessary to the analog output to pass from 100% to 2Q6 when a load is switched on.
- 2Q18** **Regulation band** (0.10÷25.00bar; 0.0÷25.0°C; 1÷250 PSI; 1÷250°F;10÷2500 KPA). It is the band with the proportional action. It replaces CP1 for the inverter regulation. It is add to the set point. The proportional action starts when the temperature/pressure value is higher than the set point and it reaches the 100% when the pressure/temperature is equal or higher than set + 2Q18.
- 2Q19** **Integral time** (0÷999s; with 0 integral action excluded). It sets the pound of the proportional action. The higher is 1Q20, the lower is the integral action support.
- 2Q20** **Band offset** (-12.0÷12.0°C -12.00 ÷ 12.00BAR, -120÷120°F, -120÷120PSI; -1200÷1200KPA). Used to move the regulation band across to the set point.
- 2Q21** **Integral action limitation** (0.0÷99.0 °C; 0÷180°F; 0.00÷50.00bar; 0÷725PSI; 0÷5000KPA) to stop the increasing of integral action when the pressure reaches the SET + 1Q22 value.

- 2Q23 Minimum inverter capacity with poor lubrication** (0÷99%; with 0 function excluded) If the frequency compressor works for the 1Q25 time with a frequency (in percentage) equal or lower than 2Q23, it is forced to work at 100% for the 2Q25 time in order to make the right lubrication.
- 2Q24 Maximum inverter functioning time at a lower frequency than 2Q24, before working at 100%** (1÷255min)
- 2Q25 Time of Inverter at 100% to restore the right lubrication** (1÷255min)

7.1.22 Analog Output 3 (3Q2-3Q26)

- 3Q2 Analog output 3 function** (term. 31-32)
FREE = pure analogue output
CPR = output for inverter frequency compressor – circuit 1
CPR2 = output for inverter frequency compressor – circuit 2
FAN = output for inverter fans – circuit 1 (only some fans driven by inverter, others enabled by on/off);
FAN2 = output for inverter fans – circuit 2 (only some fans driven by inverter, others enabled by on/off);
INVF1 = proportional inverter for fans of circuit 1 (all fans driven by inverter)
INVF2 = proportional inverter for fans of circuit 2 (all fans driven by inverter)
nu = not used
- 3Q3 Reference probe for analogue output 3**, it's used only when 3Q2 = FREE, **INVF1** or **INVF2**
Pbc1= Suction Probe, circuit 1 (term. 62-63 or 62 -68)
Pbc2 = Suction Probe, circuit 2 (term. 64-63 or 64 -68)
- 3Q4 Adjustment of read out for the analog output 3** (-1.00÷100.00 bar; -15÷750PSI; -50÷150°C; -58÷302°F; -100÷10000 KPA). It's used only when 3Q2 = FREE
- 3Q5 Adjustment of read out for the analog output 3 at 20mA/10V** (-1.00÷100.00 bar; -15÷750PSI; -50÷150°C; -58÷302°F; -100÷10000 KPA). It's used only when 3Q2 = FREE
- 3Q6 Minimum value for analogue output 3** (0 ÷ 100%)
- 3Q7 Analog output 3 value after load start** (3Q6 ÷ 100 %) It's the value of the analogue output after a compressor has started, when the pressure/temperature is above the regulation band. – *Used during inverter regulation*
- 3Q8 Analog output 3 value after a load is switched off** (3Q6 ÷ 100 %) It's the value of the analogue output when a compressor has been switched off and the the pressure/temperature is below the regulation band. – *Used during inverter regulation*
- 3Q9 Exclusion band start value for analog output 3** (3Q6 ÷ 100 %): it allows to exclude a range of frequencies that could create problems to the compressor. – *Used during inverter regulation*
- 3Q10 Exclusion band end value for analog output 3** (3Q9 ÷ 100 %) – *Used during inverter regulation*
- 3Q11 Safety value for analog output 3** (0 ÷ 100 %): it's used in case of probe faulty.
- 3Q12 Delay between the entrance in the regulation band and the regulation activation** (0 ÷ 255sec): it's the delay between the entrance in the regulation band of pressure/temperature and the regulation start. Used to avoid false inverter starts due to pressure variations. – *Used during inverter regulation.*
- 3Q13 Analog output 3 rise time** (0 ÷ 255 sec). It's the time necessary to the analog output to pass from the 3Q6 to 100%, when a compressor has started and the pressure/temperature is above the regulation band. – *Used during inverter regulation.*
- 3Q14 Analog output 3 permanency at 100% before load activation** (0 ÷ 255 sec): the analog output remains at 100% value for this time before a load is activated. – *Used during inverter regulation*
- 3Q15 Delay between pressure (temperature) goes down the set point and start of analog output 3 decreasing** (0÷255sec). – *Used during inverter regulation*
- 3Q16 Analog output decreasing time** (0 ÷ 255sec) It's the time taken from the analog output to pass from 100% to the 3Q8 value. It's used during the switching off phase, when the pressure is below the set point.
- 3Q17 Analog output 3 permanency at 3Q6 before a load is switched off** (0 ÷ 255sec) When the pressure (temperature) is below the set point, the analog output 3 remains at 3Q6 value for the 3Q17 before a load is switched off.
- 3Q18 Analog output 3 decreasing time when a load is switched on** (0 ÷ 255sec) It's the time necessary to the analog output to pass from 100% to 3Q7 when a load is switched on.
- 3Q19 Regulation band** (0.10÷25.00bar; 0.0÷25.0°C; 1÷250 PSI; 1÷250°F;10÷2500 KPA). It is the band with the proportional action. It replaces CP1 for the inverter regulation. It is add to the set point. The proportional action starts when the temperature/pressure value is higher than the set point and it reaches the 100% when the pressure/temperature is equal or higher than set + 3Q19.

- 3Q20** **Integral time** (0÷999s; with 0 integral action excluded). It sets the pound of the proportional action. The higher is 3Q20, the lower is the integral action support.
- 3Q21** **Band offset** (-12.0÷12.0°C -12.00 ÷ 12.00BAR, -120÷120°F, -1200÷1200PSI; -1200÷1200KPA). Used to move the regulation band across to the set point.
- 3Q22** **Integral action limitation** (0.0÷99.0 °C; 0÷180°F; 0.00÷50.00bar; 0÷725PSI; 0÷5000kPA) to stop the increasing of integral action when the pressure reaches the SET + 3Q22 value.
- 3Q24** **Minimum inverter capacity with poor lubrication** (0÷99%; with 0 function excluded) If the frequency compressor works for the 3Q25 time with a frequency (in percentage) equal or lower than 3Q24, it is forced to work at 100% for the 3Q26 time in order to make the right lubrication.
- 3Q25** **Time of lower inverter time** (1÷255min)
- 3Q26** **Time of Inverter at 100% to restore the right lubrication** (1÷255min)

7.1.23 Analog output 4 (4Q1-4Q25)

- 4Q1** **Analog output 4 function** (term. 30-31)
FREE = pure analogue output
CPR = output for frequency compressor – circuit 1
CPR2 = output for frequency compressor – circuit 2
FAN = output for inverter fans– circuit 1 (only some fans driven by inverter, others enabled by on/off);
FAN2 = output for inverter fans – circuit 2 (only some fans driven by inverter, others enabled by on/off);
INVF1 = proportional inverter for fans of circuit 1 (all the fans driven frequency)
INVF2 = proportional inverter for fans of circuit 2 (all the fans driven frequency)
nu = not used
- 4Q2** **Reference probe for analogue output 4**, it's used only when 4Q1 = FREE, INVF1 or INVF2.
Pbc3= Suction Probe, circuit 1 (term. 65-66 or 65 -68)
Pbc4 = Suction Probe, circuit 2 (term. 66-67 or 67 -68)
- 4Q3** **Adjustment of read out for the analog output 4 at 4mA/0V** (-1.00÷100.00 bar; -15÷750PSI; -50÷150°C; -58÷302°F; -100÷10000 KPA). It's used only when 4Q1 = FREE
- 4Q4** **Adjustment of read out for the analog output 4 at 20mA/10V** (-1.00÷100.00 bar; -15÷750PSI; -50÷150°C; -58÷302°F; -100÷10000 KPA). It's used only when 4Q1 = FREE
- 4Q5** **Minimum value for analogue output 4** (0 ÷ 100%)
- 4Q6** **Analog output 4 value after load start** (4Q5 + 100 %) It's the value of the analogue output after a compressor has started, when the pressure/temperature is above the regulation band. – *Used during inverter regulation*
- 4Q7** **Analog output 4 value after load is switched off** (4Q5 ÷ 100 %) It's the value of the analogue output when a compressor has been switched off and the the pressure/temperature is below the regulation band. – *Used during inverter regulation*
- 4Q8** **Exclusion band start value for analog output 4** (4Q5 ÷ 100 %); it allows to exclude a range of frequencies that could create problems to the compressor. – *Used during inverter regulation*
- 4Q9** **Exclusion band end value for analog output 4** (4Q8 ÷ 100 %)- *Used during inverter regulation*
- 4Q10** **Safety value for analog output 4** (0 ÷ 100 %); it's used in case of probe faulty.
- 4Q11** **Delay between the entrance in the regulation band and the regulation activation** (0 ÷ 255sec): it's the delay between the entrance in the regulation band of pressure/temperature and the regulation start. Used to avoid false frequency starts dued to pressure variations. – *Used during inverter regulation.*
- 4Q12** **Analog output 4 rise time** (0 ÷ 255 sec) It's the time necessary to the analog output to pass from the 1Q6 to 100%, when a compressor has started and the pressure/temperature is above the regulation band. – *Used during inverter regulation.*
- 4Q13** **Analog output 4 permanency before load activation** (0 ÷ 255 sec): the analog output remains at 100% value for this time before a load is activated. - *Used during inverter regulation*
- 4Q14** **Delay between pressure (temperature) goes down the set point and start of analog output 4 decreasing** (0÷255sec). – *Used during inverter regulation*
- 4Q15** **Analog output 4 decreasing time** (0 ÷ 255sec) It's the time taken from the analog output to pass from 100% to the 4Q7 value. It's used during the switching off phase, when the pressure is below the set point.
- 4Q16** **Analog output 4 permanency at 4Q5 before a load is switched off** (0 ÷ 255sec) The analog output remains at 4Q5 value before a load is switched off.
- 4Q17** **Analog output 4 decreasing time when a load is switched on** (0 ÷ 255sec) It's the time necessary to the analog output to pass from 100% to 4Q6 when a load is switched on.

- 4Q18 Regulation band** (0.10÷25.00bar; 0.0÷25.0°C; 1÷250 PSI; 1÷250°F;10÷2500 KPA). It is the band with the proportional action. It replaces CP1 for the inverter regulation. It is add to the set point. The proportional action starts when the temperature/pressure value is higher than the set point and it reaches the 100% when the pressure/temperature is equal or higher than set + 4Q18.
- 4Q19 Integral time** (0÷999s; with 0 integral action excluded). It sets the pound of the proportional action. The higher is 1Q20, the lower is the integral action support.
- 4Q20 Band offset** (-12.0÷12.0°C -12.00 ÷ 12.00BAR, -120÷120°F, -120÷120PSI; -1200÷1200KPA). Used to move the regulation band across to the set point.
- 4Q21 Integral action limitation** (0.0÷99.0 °C; 0÷180°F; 0.00÷50.00bar; 0÷725PSI; 0÷5000kPA) to stop the increasing of integral action when the pressure reaches the SET + 1Q22 value.
- 4Q23 Minimum inverter capacity with poor lubrication** (0÷99%; with 0 function excluded) If the frequency compressor works for the 1Q25 time with a frequency (in percentage) equal or lower than 4Q23, it is forced to work at 100% for the 4Q25 time in order to make the right lubrication.
- 4Q24 Maximum inverter functioning time at a lower frequency than 4Q24, before working at 100%** (1÷255min)
- 4Q25 Time of Inverter at 100% to restore the right lubrication** (1÷255min)

7.1.24 Auxiliary Outputs (ARI-ARI2)

- AR1 Set point for auxiliary relay 1 (-40÷110°C/-40÷230°F)** it's is used for all the relays configured as AUS1.
- AR2 Differential for aux relay 1 (0,1÷25,0°C/1÷50°F)** Intervention differential for relay AUX1.
Cooling (AR3 = CL): Cut IN is AR1+ AR2. Cut OUT is when the temperature reaches the set point AR1.
Heating (AR3=Ht): Cut IN is AR1- AR2. Cut OUT is when the temperature reaches the set point. AR1
- AR3 Kind of action for aux. 1**
CL = cooling
Ht = heating
- AR4 Set point for auxiliary relay 2 (-40÷110°C/-40÷230°F)** it's is used for all the relays configured as AUS2.
- AR5 Differential for aux relay 2 (0,1÷25,0°C/1÷50°F)** Intervention differential for relay AUX2.
Cooling (AR6 = CL): Cut IN is AR4+ AR5. Cut OUT is when the temperature reaches the set point AR4.
Heating (AR36 = Ht): Cut IN is AR4- AR5. Cut OUT is when the temperature reaches the set point. AR4
- AR6 Kind of action for aux. 2**
CL = cooling
Ht = heating
- AR7 Set point for auxiliary relay 3 (-40÷110°C/-40÷230°F)** it's is used for all the relays configured as AUS3.
- AR8 Differential for aux relay 1 (0,1÷25,0°C/1÷50°F)** Intervention differential for relay AUX3.
Cooling (AR3 = CL): Cut IN is AR7+ AR8. Cut OUT is when the temperature reaches the set point AR7.
Heating (AR8=Ht): Cut IN is AR7- AR8. Cut OUT is when the temperature reaches the set point. AR7-
- AR9 Kind of action for aux. 3**
CL = cooling
Ht = heating
- AR10 Set point for auxiliary relay 4 (-40÷110°C/-40÷230°F)** it's is used for all the relays configured as AUS4.
- AR11 Differential for aux relay 4 (0,1÷25,0°C/1÷50°F)** Intervention differential for relay AUX4.
Cooling (AR12 = CL): Cut IN is AR10+ AR11. Cut OUT is when the temperature reaches the set point AR10.
Heating (AR12=Ht): Cut IN is AR10- AR11. Cut OUT is when the temperature reaches the set point. AR10
- AR12 Kind of action for aux. 4**
CL = cooling
Ht = heating

7.1.25 Superheat

- ASH0 Differential for superheat pre-alarm 1 and 2** (0.1 to 15.0°C/ 1 to 30°F)

- ASH1 **Bottom limit of suction superheat alarm 1** (0.1 to 15.0°C/ 1 to 30°F)
 ASH2 **Delay for signalling suction superheat alarm 1** (0.1 to 60.0 min; res. 10s)
 ASH3 **Switching off compressors for alarm ASH1** (No, Yes)
 ASH4 **Differential for restarting suction superheat alarm control 1**
 (0.1 to 15.0°C/ 1 to 30°F)
 ASH5 **Delay for restarting control after superheat > ASH1+ASH4** (0.1 to 60.0 min; res. 10s)
 ASH6 **Superheat value 1 at which to enable valve 1 for injecting hot gas (hot action)** (0.1 to 15.0°C/ 1 to 30°F)
 ASH7 **Differential for ASH6** (0.1 to 15.0°C/ 1 to 30°F)
 ASH8 **Bottom limit of suction superheat alarm 2** (0.1 to 15.0°C/ 1 to 30°F)
 ASH9 **Delay for signalling suction superheat alarm 2** (0.1 to 60.0 min; res. 10s// This can also be calculated in seconds, providing 60 s is given as 1 min).
 ASH10 **Switching off compressors for alarm ASH8** (No, Yes)
 ASH11 **Differential for restarting suction superheat alarm control 2** (0.1 to 15.0°C/ 1 to 30°F)
 ASH12 **Delay for restarting control after superheat > ASH8+ASH11** (0.1 to 60.0 min; res. 10s)
 ASH13 **Superheat value 2 at which to enable valve 2 for injecting hot gas (hot action)** (0.1 to 15.0°C/ 1 to 30°F)
 ASH14 **Differential for ASH13** (0.1 to 15.0°C/ 1 to 30°F)

7.1.26 Other (oT1-oT9)

- OT1 **Alarm relay off by keyboard** It's referred to the relay with terminals 84-85-86
no = alarm relay remains on for all the duration of the alarm
yes = the alarm relay is switched off by pushing a key
- OT2 **Alarm relay polarity**
OP = alarm conditions 84-85 closed
CL = alarm conditions 84-85 open
- OT3 **Alarm relay 1 off by keyboard** It's referred to the relays configured as ALr1
no = alarm relay remains on for all the duration of the alarm
yes = the alarm relay is switched off by pushing a key
- OT4 **Alarm relay 1 polarity**
OP = the alarm relay terminals are open during an alarm
CL = the alarm relay terminals are closed during an alarm
- OT5 **Alarm relay 2 off by keyboard** It's referred to the relays configured as ALr2
no = alarm relay remains on for all the duration of the alarm
yes = the alarm relay is switched off by pushing a key
- OT6 **Alarm relay 2 polarity**
OP = the alarm relay terminals are open during an alarm
CL = the alarm relay terminals are closed during an alarm
- OT7 **Serial address** 1 ÷ 247
- OT8 **Serial address for keyboard** not used
- OT9 **Off function enabling**
no = it's not possible to switch the controller off by keyboard
YES = it's possible to switch the controller off by keyboard

8. REGULATION

8.1 Neutral zone adjustment – only for compressors

This kind of regulation is available only for compressors. It is used if the parameter C37 = db (C38 = db for circuit 2). The following observations are available only for adjustment **without inverter**. In this case the neutral zone (CP1) is symmetrical compared to the target set point, with extremes: set+CP1/2 ... set-CP1/2. If the pressure (temperature) is inside this zone the controller maintains the same number of loads switched on and off, without changing anything.

When the pressure (temperature) goes out from the zone, regulation starts. If the pressure is greater than SET+CP1/2, the loads are switching on with timing given by CP11 parameter.

A load is turned on only if the his safety times:

CP9 Minimum time between 2 following switching ON of the same compressor (0÷255 min).

CP10 Minimum time between the switching off of a compressor and the following switching on. (0÷255min).

Note: usually CP9 is greater than CP10

CP13 Minimum time load on (0 + 99.5 min; res. 1sec)
are over.

Regulation stops when the pressure (temperature) comes back into the neutral zone.

In the following a simplify example that explains the regulation in neutral zone for compressor homogeneous with 1 step for each compressors. The safety times **CP9**, **CP10**, **CP13** are not considered. In the real regulation the a load is entered or turned off only if these times are over.

Ex. Dead band control, compressors with same capacities, 1 step for each compressor.
In this example:

C1 = cPr1; C2 = cPr1; C3 = cPr1; number of compressors first circuit.

C35 = db dead band regulation

C39 = yES rotation

CP16 = no "CP11" delay not enabled at first calling after an equilibrium condition.

CP17 = no "CP12" delay not enabled at first calling after an equilibrium condition.

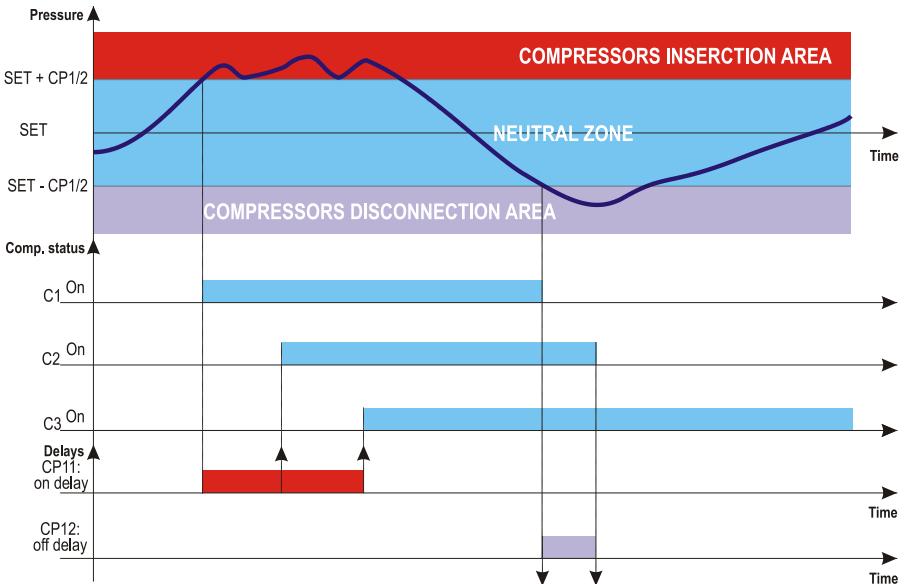

8.2 Proportional band adjustment – for compressors and fans

This kind of regulation is available for compressors and fans. It is used by compressors if the parameter C37 = Pb (C38 = Pb for circuit 2). The following observations are available only for adjustment without inverter. Compressors and fans work in the same way.

Example:

In this case the regulation band (CP1) is divided into as many parts as there are stages according to the following formula:

steps = C(i) = CPr1 or Step (number of compr. or steps).

The numbers of stages switched ON is proportional to the value of the input signal: when this distances itself from the target set point and enters the various bands, the compressors are switched ON, to be then turned OFF when the signal brings near the set point.

In this way if the pressure is greater than regulation band, all the compressors are on, if the pressure (temperature) is lower than the regulation band all the compressors are off. Naturally also for this regulations all the delays (CP11 and CP12) safety times (**CP9**, **CP10**, **CP13**) are taken in account.

Regulation according to the running hours

The algorithm switch on and off the loads according to the running hours of each load. In this way the running hours are balanced.

Example

- C1 = cPr1; C2 = cPr1; C3 = cPr1; C4 = cPr1:** 4 compressors
- C37 = cPb** proportional band regulation
- C39 = yES** rotation
- CP16 = no** "CP11" delay not enabled at first calling after a regulation zone.
- CP17 = no** "CP12" delay not enabled at first calling after a regulation zone.

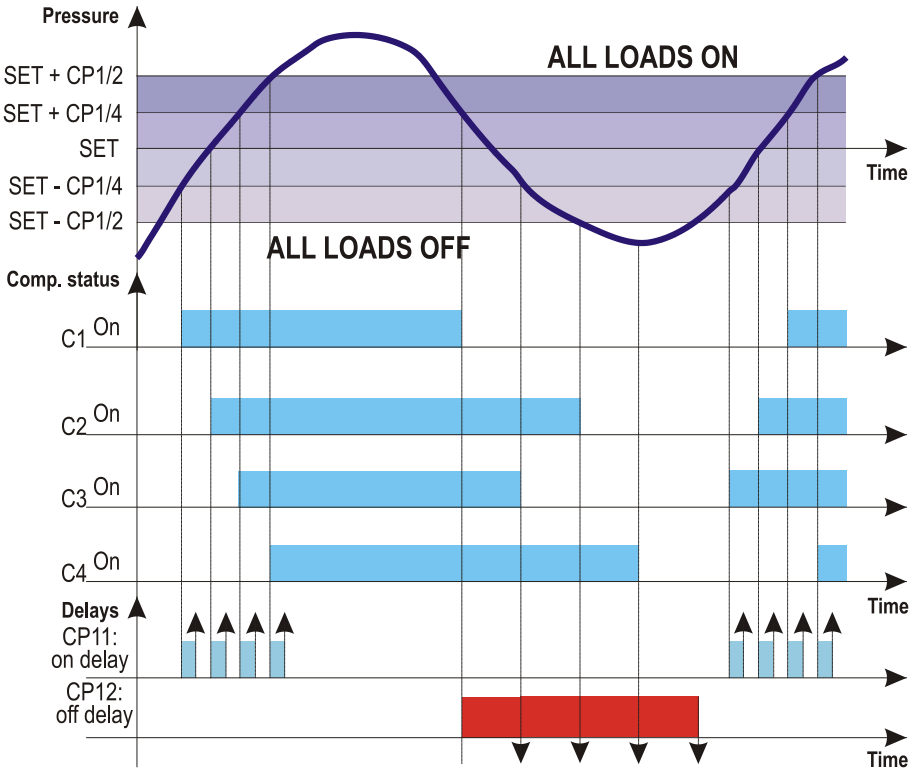

9. SCREW COMPRESSORS

Loads activation is managed by the neutral zone. They follows general rules of step compressors:

a. C1..C14 = screw1 or screw2 have to be present, following C2..C15 that are set as Stp, are linked to C1..C14 = screw

The relay group is activated depending on the kind of screw compressors that has been selected on the **C16** parameter.

9.1 Regulation with screw compressors like Bitzer/ Hanbell/ Refcomp etc

Screw compressors like Bitzer use up to 4 valves for the power regulation.

The first valve is used during the starting phase for the C35 max time, after this time, the step 2 is automatically activated.

Through the C36 parameter it is possible to decide if the step 1 can be subsequently used during the standard thermoregulation.

9.1.1 Relay activation

ES. Compressor with 4 steps:

C1 = Scrw1; **C2** = Stp; **C3** = Stp; **C4** = Stp; **C16** = Btz

a. Activation with valves ON due to voltage presence (C17=cL).

	C1 = Screw1	C2 = stp	C3 = stp	C4 = stp
Step 1 (25%)	ON	ON	OFF	OFF
Step 2 (50%)	ON	OFF	ON	OFF
Step 3 (75%)	ON	OFF	OFF	ON
Step 4 (100%)	ON	OFF	OFF	OFF

b. Activation with valves ON due to voltage absence (C17=oP).

	C1 = Screw1	C2 = stp	C3 = stp	C4 = stp
Step 1 (25%)	ON	OFF	ON	ON
Step 2 (50%)	ON	ON	OFF	ON
Step 3 (75%)	ON	ON	ON	OFF
Step 4 (100%)	ON	ON	ON	ON

9.2 Regulation with screw compressors like Frascold

Screw compressors like Frascold use up to 3 valves for the power regulation.

The first valve is used during the starting phase for the C35 max time, after this time, the step 2 is automatically activated.

Through the C36 parameter it is possible to decide if the step 1 can be subsequently used during the standard thermoregulation.

9.2.1 Relay activation

ES. Compressor with 4 steps:

C1 = Scrw1; **C2** = Stp; **C3** = Stp; **C4** = Stp; **C16** = Frtz

a. Activation with valves ON due to voltage presence. (C17=cL)

	C1 = Screw1	C2 = stp	C3 = stp	C4 = stp
C1 = Screw1	ON	OFF	OFF	OFF
C1 = Screw1	ON	ON	ON	OFF
C1 = Screw1	ON	ON	OFF	ON
C1 = Screw1	ON	ON	OFF	OFF

b. Activation with valves ON due to voltage absence. (C17=oP)

	oAi = Screw1	oAi+1 = stp	oAi+2 = stp	oAi+3 = stp
Step 1 (25%)	ON	ON	ON	ON
Step 2 (50%)	ON	OFF	OFF	ON
Step 3 (75%)	ON	OFF	ON	OFF
Step 4 (100%)	ON	OFF	ON	ON

10. ANALOG OUTPUTS FOR INVERTER

10.1 Compressor management

The analog outputs can be used in a rack with frequency compressor, driven by an inverter. The regulation of the compressors in this case is changed as described in the following graph: The following examples shows the behaviour of the analog output with proportional regulation.

ES.

3 compressors, 1 frequency compressor

C1 = FRQ1 C37 = db 1Q8 < 100

C2 = CPR1 1Q2 = CPR

C3 = CPR1 1Q7 < 100

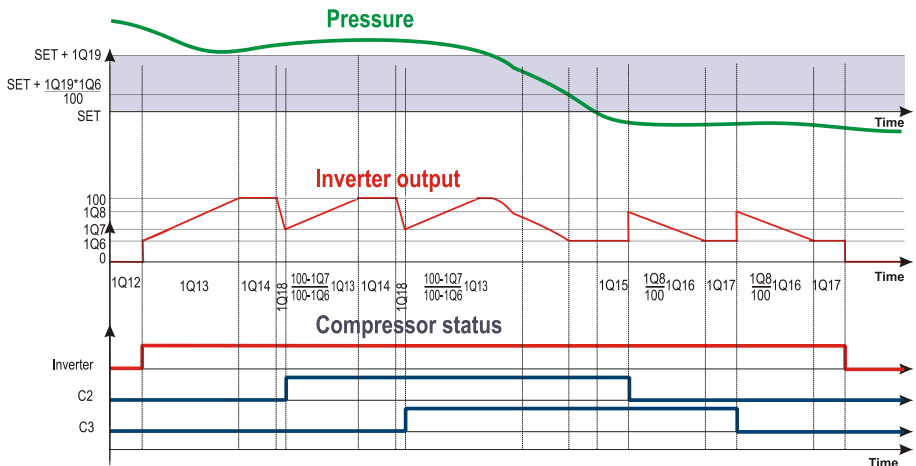

where

1Q6	Minimum value for analog out.1	0 ÷ 100 %
1Q7	Analog output1 value after compressor on	1Q6 ÷ 100 %
1Q8	Analog output1 value after compressor off	1Q6 ÷ 100 %
1Q12	Regulation delay after entering the regulation band	0 ÷ 255 (sec)
1Q13	Analog output 1 rise time from 1Q6 to 100% when the pressure is above the regulation band and a load is switched on.	0 ÷ 255 (sec)
1Q14	Analog output 1 permanency at 100% before load activation	0 ÷ 255 (sec)
1Q15	Delay between pressure (temperature) goes down the set point and start of analog output 1 decreasing	0 ÷ 255 (sec)
1Q16	Analog output 1 decreasing time from 100% to the 1Q6 value	0 ÷ 255 (sec)
1Q17	Analog output1 permanency at 1Q6 before a load is switched off	0 ÷ 255 (sec)
1Q18	Analog output1 decreasing time, from 100% to 1Q7 when a load is switched on	0 ÷ 255 (sec)

EX.

3 compressors, 1 frequency compressor,

C1 = FRQ1 C37 = db 1Q8 = 100
C2 = CPR1 1Q2 = CPR
C3 = CPR1 1Q7 = 100

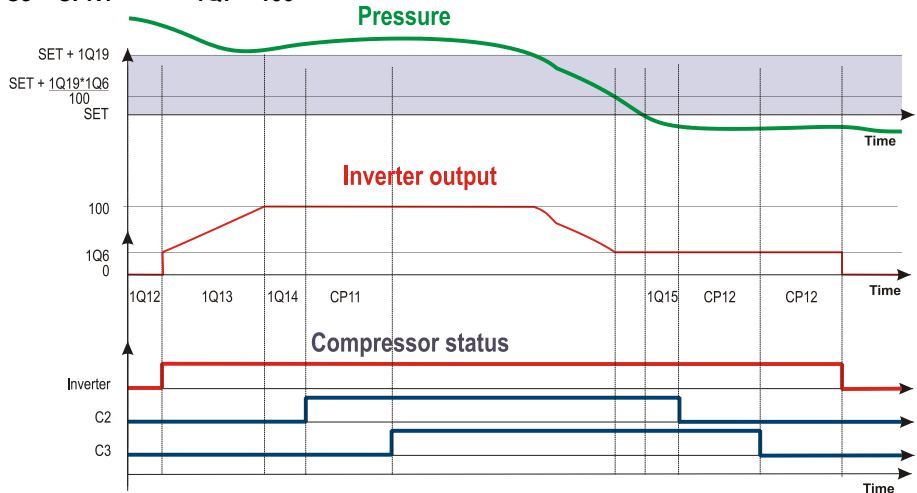

where

1Q6	Minimum value for analog out.1	0 ÷ 100 %
1Q12	Regulation delay after entering the regulation band	0 ÷ 255 (sec)
1Q14	Analog output 1 permanency at 100% before load activation	0 ÷ 255 (sec)
1Q15	Delay between pressure (temperature) goes down the set point and start of analog output 1 decreasing	0 ÷ 255 (sec)
CP11	2 different load start delay	0 ÷ 99.5 (min.1sec)
CP12	2 different load off delay	0 ÷ 99.5 (min.1sec)

10.2 Fans management with inverter– 1 fans group with inverter mode, others ON in on/off mode

With this configuration, one analog output can be used to drive the inverter (1Q2 or 2Q1 or 3Q2 or 4Q1 = FAN or FAN2). Set the first fans relay as inverter (FRQ1F or FRQ2F), and other relays as fans (FAN1 or FAN2).

ES.: 4 fans, 1 with inverter. Analog output 1 drives the inverter

C1 = FRQ1F
C2 = FAN1
C3 = FAN1
C4 = FAN1

1Q2 = FAN

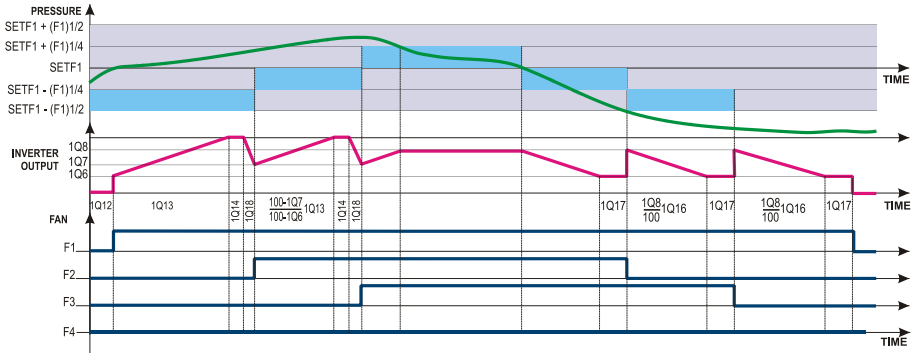

- 1Q6** Minimum value for analog output 1 0 ÷ 100 %
- 1Q7** Analog output 1 value after fan activation 1Q6 ÷ 100 %
- 1Q8** Analog output 1 value after fan deactivation 1Q6 ÷ 100 %
- 1Q12** Regulation delay of analog output 1 when the pressure is in the regulation band 0 ÷ 255 (sec)
- 1Q13** Analog output 1 rise time from 1Q6 to 100% when the pressure is outside the regulation band 0 ÷ 255 (sec)
- 1Q14** Analog output 1 permanency at 100% before load activation 0 ÷ 255 (sec)
- 1Q16** Analog output 1 decreasing time from 100% to 1Q6 0 ÷ 255 (sec)
- 1Q17** Analog output 1 permanency at 1Q6 before a fan is switched off with pressure below the set 0 ÷ 255 (sec)
- 1Q18** Analog output 1 decreasing time, from 100% to 1Q7 before a load is switched on 0 ÷ 255 (sec)

10.3 Management of all fans with inverter – proportional inverter

In this case all fans of the condensing group are driven by one inverter. The power used by the inverter is proportional to the delivery pressure value.

Set one relay as inverter (FRQ1F or FRQ2F) and set the analog output 3 or 4 to drive it (3Q2 or 4Q1 = INVF1 or INVF2).

The reference probe is the probe set on parameter 3Q3 or 4Q2 = PBC3 or PBC4, respectively the delivery probe circuit 1 and 2.

The analog output is managed in proportional mode according to the pressure/temperature between the SETF and the SETF1 + 3Q19 (or 4Q18).

Below the SETF the output is OFF, above the SETF the output works at 100%.

If the delivery pressure/temperature is higher than the SETF1(2) value, the relay set as inverter is ON; if the delivery pressure is lower than the SETF1(2) value the relay is OFF.

10.3.1 Use of fans thermal protection

With this configuration it's possible to use XC1000D digital inputs to monitor the fans functioning.

It's necessary to set as much relay as used fans. Connect the thermal protection of every fans to its digital input of the relay set as fan.
DON'T USE relays set as fans.

ES.: 4 fans, driven by one inverter.

C1 = FRQ1F C2 = FAN1 C3 = FAN1 C4 = FAN1 C5 = FAN1
3Q2 = INV F1 3Q3 = PBC3 3Q19 = Regulation band width
3Q6= min. value analog output

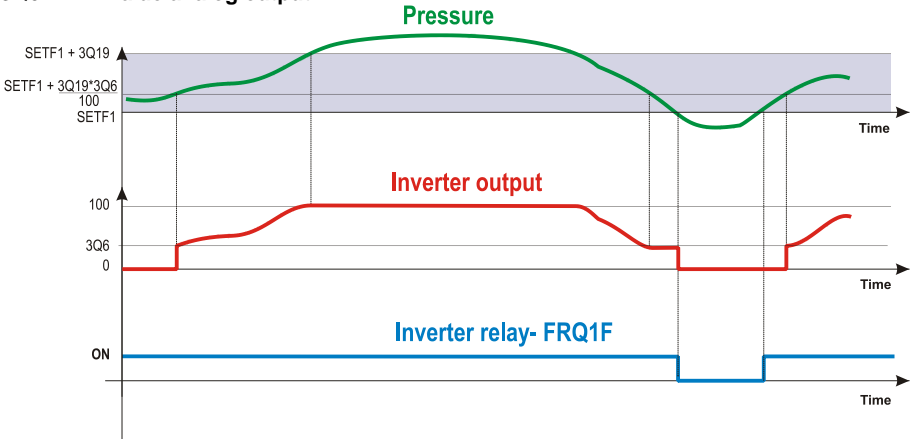

With this configuration, connect the thermal protection of:

- fan 1 to terminals: 5-6 (i.d. 2)
- fan 2 to terminals: 7-8 (i.d. 3)
- fan 3 to terminals: 9-10 (i.d. 4)
- fan 4 to terminals: 11-12 (i.d. 5)

In this way any fans problem is sent to the controller (even if doesn't affect the regulation)

10.4 Liquid injection valve activation for raising superheat – subcritical Co2 application

10.4.1 Configuration

Configure:

- 1 auxiliary probe for calculating superheat E.g.: Ai17 = SH1
- 1 relay as injection valve E.g. C15 = Valv1.

10.4.2 Adjustment

The relay configured as Valv1 works as a thermostat with inverse action (hot), using the superheat value as the control variable.

SH1 = (Probe temp. set as SH1) – (Temp. of suction 1)

with SH1 < ASH6 – ASH7 → Valv1 on
 with SH1 > ASH6 → Valv1 off

with ASH6 < SH1 < ASH6 – ASH7 → maintains the status.

10.4.3 Particular cases

- a. If no aux probe is configured for calculating the SH1 and a relay is set as Valv1, the “error no probe for SH1” is generated and the Valv1 relay will never be enabled.
- b. If the AUX probe configured for calculating the SH1 is in error mode, the probe alarm is generated and the Valv1 relay is not enabled.

10.5 Temperature/pressure value at which to turn off the compressors (electronic pressure switch).

The AC1 and AC 22 parameters determine the low pressure/temperature thresholds for the compressor set of circuit 1 and 2 respectively, for when the pressure/temperature is too low (electronic pressure switch).

If the suction pressure of circuit 1 or 2 falls below the value, the low pressure alarm is generated and the compressors can be turned off.

10.5.1 Conduct

The compressors of circuit 1 or 2 are stopped when the set threshold is reached (as if the minimum pressure switch were activated).

The low pressure alarm is generated and the alarm relay set in parameter AC9 is activated.

10.6 Plant with probe input 63 –64: (Suction probe – circuit 2) as input for dynamic set of suction 1

In this case the probe input for suction 2 (63-64) is used as a driver signal for dynamic set for suction 1.

Activation criteria:

C0 = 1A1dO

A11 = cur or rAt

o1 = YES

If o1 = no, there is no error for probe P2.

This configuration cancels the traditional dynamic setpoint for suction 1.

The probe P2 error resets the SET_Asp1 work setpoint.

11. ALARM LIST

Usually alarm conditions are signalled by means of:

1. Activation of alarm relays
2. Buzzer activation
3. Message on proper display
4. Log of alarms, hour, data and duration

11.1 Alarm conditions – summary table

Code	Description	Cause	Action	Reset
E0L1 (E0L2)	Low pressure-switch alarm for circuit 1 (2)	Low pressure switch input 1 (2) enabled, terminals 52-53 (56-57).	- All compressors of circuit 1 (2) are turned off. Fans unchanged.	Automatically if the number of activation are less than Ac12 (Ac16) in the Ac13 (Ac17) time when the input is disable. - The compressors restarts working according to the working algorithm. Manually (if Ac12 (Ac16) activation happened in the Ac13 (Ac17) time When the input is disable: a. turn off and on the instrument. - The compressors restarts working according to the working algorithm.
E0H1 (E0H2)	High pressure switch fro circuit 1 (2) alarm	High pressure switch input 1 (2) enabled - terminals 54-55 (58-59)	- All compressors of circuit 1 (2) are turned off. - All fans are of circuit 1 (2) turned on.	Automatically if the number of activation are less than AF7 (AF14) in AF8 (AF15) time when the input is disable. - Compressors and fans restart working according to the working algorithm. Manually if AF7 (AF14) activation happened in the AF8 (AF15) time When the input is disable: - turn off and on the instrument. Compressors and fans restarts working according to the working algorithm.
P1 (P2)	Suction probe circuit 1 (2) failure alarm	Probe 1 (2) failure or out of range	- The compressors are activated according to the AC14 (AC18) parameters.	Automatically as soon as the probe restarts working.
P3 (P4)	Condensing probe circuit 1 (2) failure alarm	Probe 3 (4) failure or out of range	- The fans are activated according to the AF8 (AF16) parameters.	Automatically as soon as the probe restarts working.

Code	Description	Cause	Action	Reset
EA1+ EA15	Compressor safeties alarm	Safeties compressor input activation. NOTE: with step compressors 1 input for each compressor has to be used.	– the corresponding compressor is turned off. (with step compressors all relays referred to the input are disabled).	Automatically as soon as the input is disabled.
A02F	Fan safeties alarm	Safeties fan input activation.	– The corresponding output is disabled	Automatically as soon as the input is disabled.
LAC1 (LAC)	Minimum pressure (temperature) alarm compressors for circuit 1 (2)	Suction pressure or temperature lower than SETC1-AC3 (SETC2 –AC6) value	– signalling only	Automatically: as soon as the pressure or temperature reaches the SETC1-AC3 (SETC2 – AC6) + differential value. (differential = 0.3bar or 1°C)
LAF1 (LAF2)	Minimum pressure (temperature) alarm fans section for circuit 1 (2)	Condensing pressure or temperature lower than SETF1-AF1 (SETF2 –AF9) value	– signalling only	Automatically: as soon as the pressure or temperature reaches the (SETF1-AF1 (SETF2 – AF9) + differential) value. (differential = 0.3bar or 1°C)
HAC1 (HAC2)	Maximum pressure (temperature) alarm compressors for circuit 1 (2)	Suction pressure or temperature higher than SETC1+AC4 (SETC2 +AC7) value	– signalling only	Automatically: as soon as the pressure or temperature reaches the (SETC1-AC4 (SETC2 – AC7) - differential) value. (differential = 0.3bar or 1°C)
HAF1 (HAF2)	Maximum pressure (temperature) alarm fans section for circuit 1 (2)	Condensing pressure or temperature higher than SETF1+AF2 (SETF2 +AF10) value	– It depends on parameter AF4 (AF12)	Automatically: as soon as the pressure or temperature reaches the SETF1+AF2 (SETF2 +AF10) - differential value. (differential = 0.3bar or 1°C)
LL1(LL2)	Liquid level alarm for circuit 1 (2)	Proper digital input enabled	– signalling only	Automatically as soon as the input is disabled
Clock failure	Clock failure alarm	Problem on RTC board	– signalling only With this alarm the activation by RTC of the reduced set point and the alarm log are not available.	Manually: it is necessary to replace the RTC board.

Code	Description	Cause	Action	Reset
Set clock	Clock data lost	The clock back up battery is exhausted	<ul style="list-style-type: none"> - signalling only - With this alarm the activation by RTC of the reduced set point and the alarm log are not available. 	Manually: set the data and the time
SEr1÷SEr15	Compressor maintenance alarm	A compressor has worked for the time set in the AC10 parameter	- signalling only	Manually: reset the running hour of the compressor (see par. 5.5)
PrSH1 (PrSH2)	Pre-alarm for superheat 1 (2)	Superheat 1 (2) is less than $ASH0 + ASH1$ ($ASH8+ASH0$)	Signal only	Automatic: when superheat exceeds $ASH0 + ASH1 + 1^{\circ}C$ ($ASH8+ASH0+1^{\circ}C$)
ALSH1 (ALSH2)	Alarm for superheat 1 (2)	Superheat 1 (2) is less than $ASH1$ ($ASH8$)	Depends on ASH3	Automatic: when superheat exceeds $ASH4 + ASH1$ ($ASH8+ASH11$)
LPC1 (LPC2)	Electronic pressure switch for low temperature/pressure of circuit 1 (2)	Pressure/temperature < AC20 (AC22)	Disables the compressors	Automatic: when the pressure/temperature exceeds AC20 (AC22)

12. CONFIGURATION ERRORS

Error N.	Parameters	Alarm description	Action
1	C1-C15 different from Screw1 or Screw2 C16 = Btz or Frsc	Compressors configuration alarm. Set properly par. C16	Machine stop (all relays configured as compr. or fans OFF)
2	One of C1-C15 parameters = Screw1 or Screw2 C16 = SPo	Compressors configuration alarm. Set properly par. C16	Machine stop (all relays configured as compr. or fans OFF)
3	One of C1-C15 parameters configured as StP. Don't configure any C1-C15 parameter as compressor.	Presence valve without compressor	Machine stop (all relays configured as compr. or fans OFF)
4	One of C1-C15 parameters = Frq1 after CPR1; One of C1-C15 parameters = Frq2 after CPR2	Compressor before inverter: check C1-C15 parameters or More than one relay set as inverter: check C1-C15 parameters. or One relay set as frequency compressors and none analog output set: check C1-C15 parameters and: 1Q2, 2Q1, 3Q2, 4Q1.	Machine stop (all relays configured as compr. or fans OFF)
5	One of C1-C15 parameters = Frq1F after FAN1; One of C1-	Fan before inverter: check C1-C15 parameters.	Machine stop (all relays configured as compr. or fans OFF)

Error N.	Parameters	Alarm description	Action
	C15 parameters = Frq2F after FAN2	<p>or</p> <p>More than one relay set as inverter: check C1-C15 parameters.</p> <p>or</p> <p>One relay set as fan inverter and no analog output set: check C1-C15 parameters and: 1Q2, 2Q1, 3Q2, 4Q1.</p>	fans OFF)
6	One of C1-C15 parameters = Screw1 or Screw2 followed by more than 3 stp C16 = Btz or Frsc	Number of wrong compressor steps: check C1-C15 parameters.	Machine stop (all relays configured as compr. or fans OFF)

13. MOUNTING & INSTALLATION

The instruments are suitable only for internal use. They are din rail mounted.

The ambient operating temperature range is between 0÷60°C.

Avoid locations subject to heavy vibration, corrosive gases or excessive dirt. The same applies to the probes. Ensure ventilation around the instrument.

13.1 XC1000D dimensions



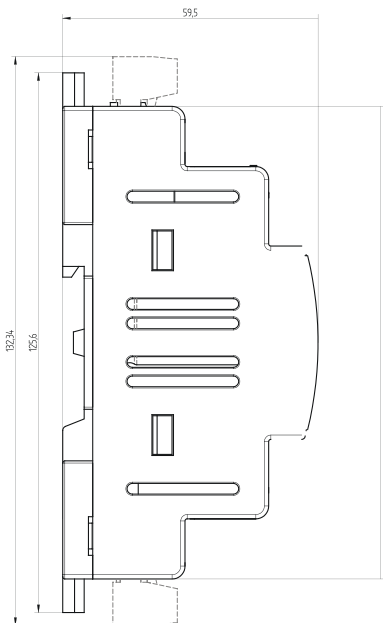

13.2 VG810 dimensions and mounting

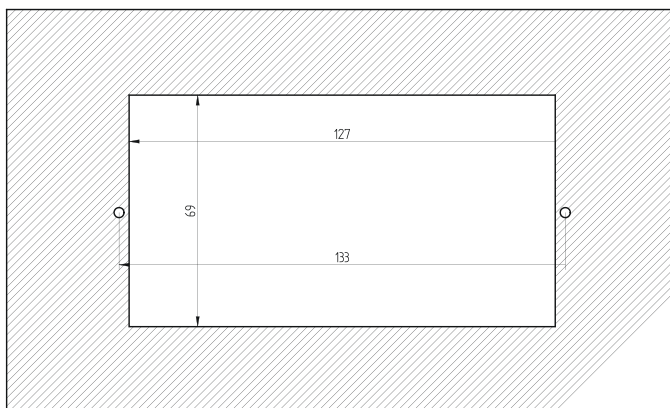

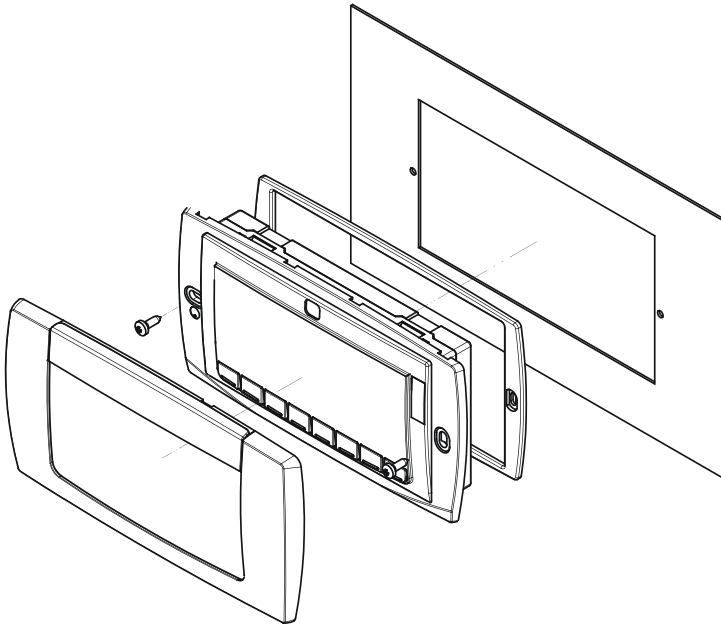

14. ELECTRICAL CONNECTIONS

The instruments are provided with disconnectable screw terminal blocks to connect cables with a cross section up to 2,5 mm².

Before connecting cables make sure the power supply complies with the instrument's requirements. Separate the input connection cables from the power supply cables, from the outputs and the power connections. **Do not exceed the maximum current allowed on each relay**, in case of heavier loads use a suitable external relay.

14.1 Probes connection

Pressure probe (4 - 20 mA): respect the polarity. If using terminal ends be sure there are no bear parts which could cause short circuiting or introduce noise disturbance at high frequencies. To minimise the induced disturbances use shielded cables with the shield connected to earth.

Temperature probe: it is recommended to place the temperature probe away from direct air streams to correctly measure the temperature.

15. RS485 SERIAL LINK

All models can be integrated into the monitoring and alarm system using the RS485 serial port. They use the standard ModBus RTU protocol, so they can be fitted in a system integrator using this protocol.

16. TECHNICAL FEATURES

Housing: plastic self extinguishing V0.

Case: 175x132 mm; depth 60 mm.

Mounting: DIN rail mounting

Number of configurable relays: **XC1015D:** 15 (relè 7A 250Vac)

XC1011D: 11 (relè 7A 250Vac)

XC1008D: 8 (relè 7A 250Vac)

Analog inputs:

XC1011D, XC1015D: 4 x 4-20mA o 0÷5V o NTC configurable probe.

XC1008D: 2 x 4-20mA o 0÷5V o NTC configurable probe.

Safety alarm inputs – main voltage:

XC1008D: 8, main voltage, connected to the loads

XC1011D: 11, main voltage, connected to the loads

XC1015D: 15, main voltage, connected to the loads

Configurable digital input:

XC1011D, XC1015D: 4, free voltage.

XC1008D: 2, free voltage.

Safety Pressure switch inputs

XC1011D, XC1015D: 4 main voltage, LP and HP.

XC1008D: 2 main voltage, LP and HP.

Global Alarm output: 1 relay 8A 250Vac

Power supply: 24Vac/dc \pm 10%,

Alarm logger: the last 100 alarm conditions are stored and displayed

Easy programming: via hot- key

Communication Protocol: Standard ModBus RTU, full documented

Operating temperature: 0÷60°C

Storage temperature: -30÷85 °C

Resolution: 1/100 Bar, 1/10 °C, 1 °F, 1 PSI

Accuracy: better than 1% of F.S.

RTC back up battery: full load battery: typical: 6 months, minimum: 4 month

EAC

17. DEFAULT SETTING

Nome	XC 1008D	XC 1011D	XC 1015D	Level	Description	Range
SETC1	-18,0	-18,0	-18,0	Pr1	Compressor set point circuit 1	
SETF1	35,0	35,0	35,0	Pr1	Fan set point circuit 1	
SETC2	-18,0	-18,0	-18,0	Pr1	Compressor set point circuit 2	
SETF2	35,0	35,0	35,0	Pr1	Fan set point circuit 2	
C0	1A1d	1A1D	1A1D	Pr2	Kind of plant	0A1d(0) - 1A0d(1) - 1A1d(2) - 0A2d(3) - 2A0d(4) - 2A1d(5) - 2A2d(6) - 1A1do
C1	CPr1	CPr1	CPr1	Pr2	Relay 1 configuration	Frq1; Frq2; CPr1; CPr2; SiP; Frq1F; Frq2F; FAn1; FAn2; ALr; ALr1; ALr2; AUS1; AUS2; AUS3; AUS4; onF; nu
C2	CPr1	CPr1	CPr1	Pr2	Relay 2 configuration	Frq1; Frq2; CPr1; CPr2; SiP; Frq1F; Frq2F; FAn1; FAn2; ALr; ALr1; ALr2; AUS1; AUS2; AUS3; AUS4; onF; Valv1; Valv2; nu
C3	CPr1	CPr1	CPr1	Pr2	Relay 3 configuration	Frq1; Frq2; CPr1; CPr2; SiP; Frq1F; Frq2F; FAn1; FAn2; ALr; ALr1; ALr2; AUS1; AUS2; AUS3; AUS4; onF; Valv1; Valv2; nu
C4	CPr1	CPr1	CPr1	Pr2	Relay 4 configuration	Frq1; Frq2; CPr1; CPr2; SiP; Frq1F; Frq2F; FAn1; FAn2; ALr; ALr1; ALr2; AUS1; AUS2; AUS3; AUS4; onF; Valv1; Valv2; nu
C5	Fan1	CPr1	CPr1	Pr2	Relay 5 configuration	Frq1; Frq2; CPr1; CPr2; SiP; Frq1F; Frq2F; FAn1; FAn2; ALr; ALr1; ALr2; AUS1; AUS2; AUS3; AUS4; onF; Valv1; Valv2; nu
C6	Fan1	Fan1	Fan1	Pr2	Relay 6 configuration	Frq1; Frq2; CPr1; CPr2; SiP; Frq1F; Frq2F; FAn1; FAn2; ALr; ALr1; ALr2; AUS1; AUS2; AUS3; AUS4; onF; Valv1; Valv2; nu
C7	Fan1	Fan1	Fan1	Pr2	Relay 7 configuration	Frq1; Frq2; CPr1; CPr2; SiP; Frq1F; Frq2F; FAn1; FAn2; ALr; ALr1; ALr2; AUS1; AUS2; AUS3; AUS4; onF; Valv1; Valv2; nu
C8	Fan1	Fan1	Fan1	Pr2	Relay 8 configuration	Frq1; Frq2; CPr1; CPr2; SiP; Frq1F; Frq2F; FAn1; FAn2; ALr; ALr1; ALr2; AUS1; AUS2; AUS3; AUS4; onF; Valv1; Valv2; nu
C9	-	Fan1	Fan1	Pr2	Relay 9 configuration	Frq1; Frq2; CPr1; CPr2; SiP; Frq1F; Frq2F; FAn1; FAn2; ALr; ALr1; ALr2; AUS1; AUS2; AUS3; AUS4; onF; Valv1; Valv2; nu
C10	-	Fan1	Fan1	Pr2	Relay 10 configuration	Frq1; Frq2; CPr1; CPr2; SiP; Frq1F; Frq2F; FAn1; FAn2; ALr; ALr1; ALr2; AUS1; AUS2; AUS3; AUS4; onF; Valv1; Valv2; nu
C11	-	FAn1	nu	Pr2	Relay 11 configuration	Frq1; Frq2; CPr1; CPr2; SiP; Frq1F; Frq2F; FAn1; FAn2; ALr; ALr1; ALr2; AUS1; AUS2; AUS3; AUS4; onF; Valv1; Valv2; nu
C12	-	-	nu	Pr2	Relay 12 configuration	Frq1; Frq2; CPr1; CPr2; SiP; Frq1F; Frq2F; FAn1; FAn2; ALr; ALr1; ALr2; AUS1; AUS2; AUS3; AUS4; onF; Valv1; Valv2; nu
C13	-	-	nu	Pr2	Relay 13 configuration	Frq1; Frq2; CPr1; CPr2; SiP; Frq1F; Frq2F; FAn1; FAn2; ALr; ALr1; ALr2; AUS1; AUS2; AUS3; AUS4; onF; Valv1; Valv2; nu
C14	-	-	nu	Pr2	Relay 14 configuration	Frq1; Frq2; CPr1; CPr2; SiP; Frq1F; Frq2F; FAn1; FAn2; ALr; ALr1; ALr2; AUS1; AUS2; AUS3; AUS4; onF; Valv1; Valv2; nu
C15	-	-	nu	Pr2	Relay 15 configuration	Frq1; Frq2; CPr1; CPr2; SiP; Frq1F; Frq2F; FAn1; FAn2; ALr; ALr1; ALr2; AUS1; AUS2; AUS3; AUS4; onF; Valv1; Valv2; nu
C16	SPo	SPo	SPo	Pr2	Kind of compressors	SPo(0) - dPo(1)
C17	CL	cL	cL	Pr2	Valve polarity circuit 1	OP - CL
C18	-	cL	cL	Pr2	Valve polarity circuit 2	OP - CL
C34	404	0	0	Pr2	Kind of gas for circuit 1	R22; r134, r404A, r407A, r410, r507, r407C,

Nome	XC 1008D	XC 1011D	XC 1015D	Level	Description	Range
						r407F, r290, CO2; r450A; r513; r448; r449; r32; r1234ze.
C35	60	0	0	Pr2	Screw compressors' second step activation delay	0 ÷ 255
C36	NO	0	0	Pr2	Screw compressors' first step used in regulation	0 ÷ 255
C37	db	0	0	Pr2	Regulation for compressor circuit 1	0 ÷ 255
C38	-	0	0	Pr2	Regulation for compressor circuit 2	0 ÷ 255
C41	YES	0	0	Pr2	Compressor rotation circuit 1	0 ÷ 255
C42	-	0	0	Pr2	Compressor rotation circuit 2	0 ÷ 255
C45	YES	0	0	Pr2	Fan rotation circuit 1	0 ÷ 255
C44	-	0	0	Pr2	Fan rotation circuit 2	0 ÷ 255
C45	C / dec	0	0	Pr2	Displaying measurement unit	0 ÷ 255
C46	rEL	0	0	Pr2	Pressure display (rel/abs)	0 ÷ 255
C47	404	0	0	Pr2	Kind of gas for circuit 2	R22; r134, r404A, r407A, r410, r507, r407C, r407F, r290, CO2; r450A; r513; r448; r449; r32; r1234ze.
AI1	Cur	Cur	Cur	Pr2	Kind of probe of P1 & P2	Cur(0) - Ptc(1) - ntc(2) - rAt(3)
AI2	-0,5	-0.50	-0.50	Pr2	Probe 1 readout at 4mA/0V	(-1.00 ÷ AI3) ^{BAR} (-15 ÷ AI3) ^{PSI}
AI3	11,0	11.00	11.00	Pr2	Probe 1 readout at 20mA/5V	(AI2 ÷ 100.00) ^{BAR} (AI2 ÷ 750) ^{PSI}
AI4	0,0	0.0	0.0	Pr2	Probe 1 calibration	(dEU=bar °C) -12.0 ÷ 12.0 (dEU=PSI °F) -120 ÷ 120
AI5	-	-0.50	-0.50	Pr2	Probe 2 readout at 4mA/0V	(-1.00 ÷ AI6) ^{BAR} (-15 ÷ AI6) ^{PSI}
AI6	-	11.00	11.00	Pr2	Probe 2 readout at 20mA/5V	(AI5 ÷ 100.00) ^{BAR} (AI5 ÷ 750) ^{PSI}
AI7	-	0.0	0.0	Pr2	Probe 2 calibration	(dEU=bar °C) -12.0 ÷ 12.0 (dEU=PSI °F) -120 ÷ 120
AI8	Cur	Cur	Cur	Pr2	Kind of probe of P3 & P4	Cur(0) - Ptc(1) - ntc(2) - rAt(3)
AI9	0,0	0.00	0.00	Pr2	Probe 3 readout at 4mA/0V	(-1.00 ÷ AI10) ^{BAR} (-15 ÷ AI10) ^{PSI}
AI10	30,0	30.00	30.00	Pr2	Probe 3 readout at 20mA/5V	(AI9 ÷ 100.00) ^{BAR} (AI9 ÷ 750) ^{PSI}
AI11	0,0	0.0	0.0	Pr2	Probe 3 calibration	(dEU=bar °C) -12.0 ÷ 12.0 (dEU=PSI °F) -120 ÷ 120
AI12	-	0.00	0.00	Pr2	Probe 4 readout at 4mA/0V	(-1.00 ÷ AI13) ^{BAR} (-15 ÷ AI13) ^{PSI}
AI13	-	30.00	30.00	Pr2	Probe 4 readout at 20mA/5V	(AI12 ÷ 100.00) ^{BAR} (AI12 ÷ 750) ^{PSI}
AI14	-	0.0	0.0	Pr2	Probe 4 calibration	(dEU=bar °C) -12.0 ÷ 12.0 (dEU=PSI °F) -120 ÷ 120
AI15	ALr	ALr	ALr	Pr2	Alarm relay for regulation faulty probe	nu - ALr - ALr1 - ALr2
AI16	ntc	Ntc	Ntc	Pr1	Probe 5 setting (ntc/ptc)	ptc(0) - ntc(1)
AI17	nu	nu	nu	Pr1	Probe 5 action type	nu = not used ; Au1 = Probe for AUX1 thermostat; Au2 = Probe for AUX2 thermostat; Au3 = Probe for AUX3 thermostat; Au4 = Probe for AUX4 thermostat; otC1 = dynamic set point for delivery – circuit 1 otC2 = dynamic set point for delivery – circuit 2 ota1 = dynamic set point for suction – circuit 1 ota2 = dynamic set point for suction – circuit 2 SH1 = superheat 1; SH2 = superheat 2
AI18	0,0	0.0	0.0	Pr1	Probe 5 calibration	(dEU=bar °C) -12.0 ÷ 12.0 (dEU=PSI °F) -120 ÷ 120
AI19	ntc	Ntc	Ntc	Pr1	Probe 6 setting (ntc/ptc)	ptc(0) - ntc(1)
AI20	nu	nu	nu	Pr1	Probe 6 action type	nu = not used ; Au1 = Probe for AUX1 thermostat; Au2 = Probe for AUX2 thermostat; Au3 = Probe for AUX3 thermostat; Au4 = Probe for AUX4 thermostat; otC1 = dynamic set point for delivery – circuit 1 otC2 = dynamic set point for delivery – circuit 2

Nome	XC 1008D	XC 1011D	XC 1015D	Level	Description	Range
						otA1 = dynamic set point for suction – circuit 1 otA2 = dynamic set point for suction – circuit 2 SH1 = superheat 1; SH2 = superheat 2
AI21	0,0	0.0	0.0	Pr1	Probe 6 calibration	(dEU=bar o °C) -12,0 ÷ 12,0 (dEU=PSI o °F) -120 ÷ 120
AI22	ntc	Ntc	Ntc	Pr1	Probe 7 setting (ntc/ptc)	ptc(0) - ntc(1)
AI23	nu	nu	nu	Pr1	Probe 7 action type	nu = not used ; Au1 = Probe for AUX1 thermostat; Au2 = Probe for AUX2 thermostat; Au3 = Probe for AUX3 thermostat; Au4 = Probe for AUX4 thermostat; otC1 = dynamic set point for delivery – circuit 1 otC2 = dynamic set point for delivery – circuit 2 otA1 = dynamic set point for suction – circuit 1 otA2 = dynamic set point for suction – circuit 2 SH1 = superheat 1; SH2 = superheat 2
AI24	0,0	0.0	0.0	Pr1	Probe 7 calibration	(dEU=bar o °C) -12,0 ÷ 12,0 (dEU=PSI o °F) -120 ÷ 120
AI25	ntc	Ntc	Ntc	Pr1	Probe 8 setting (ntc/ptc)	ptc(0) - ntc(1)
AI26	nu	nu	nu	Pr1	Probe 8 action type	nu = not used ; Au1 = Probe for AUX1 thermostat; Au2 = Probe for AUX2 thermostat; Au3 = Probe for AUX3 thermostat; Au4 = Probe for AUX4 thermostat; otC1 = dynamic set point for delivery – circuit 1 otC2 = dynamic set point for delivery – circuit 2 otA1 = dynamic set point for suction – circuit 1 otA2 = dynamic set point for suction – circuit 2 SH1 = superheat 1; SH2 = superheat 2
AI27	0,0	0.0	0.0	Pr1	Probe 8 calibration	(dEU=bar o °C) -12,0 ÷ 12,0 (dEU=PSI o °F) -120 ÷ 120
AI28	ALr	ALr	ALr	Pr1	Alarm relay for AUX faulty probe	nu - ALr - ALr1 - ALr2
DI2	cL	CL	CL	Pr2	LP swtich polarity - circuit 1	OP - CL
DI3	-	CL	CL	Pr2	LP swtich polarity - circuit 2	OP - CL
DI4	cL	CL	CL	Pr2	HP swtich polarity - circuit 1	OP - CL
DI5	-	CL	CL	Pr2	HP swtich polarity - circuit 2	OP - CL
DI6	ALr	ALr	ALr	Pr2	Relay for pressure switch alarm	nu - ALr - ALr1 - ALr2
DI7	cL	CL	CL	Pr2	Safe input polarity compressor circuit 1	OP - CL
DI8	-	CL	CL	Pr2	Safe input polarity compressor circuit 2	OP - CL
DI9	cL	CL	CL	Pr2	Safety input polarity fan circuit 1	OP - CL
DI10	-	CL	CL	Pr2	Safety input polarity fan circuit 2	OP - CL
DI11	no	NO	NO	Pr2	Manual restart for compressor alarm	no - YES
DI12	no	NO	NO	Pr2	Manual restart for fan alarm	no - YES
DI13	ALr	ALr	ALr	Pr2	Relay for compressor or fan alarm	nu - ALr - ALr1 - ALr2
DI14	CL	CL	CL	Pr1	Polarity of configurable digital input 1	OP - CL
DI15	LL1	LL1	LL1	Pr1	Function of configurable digital input 1	ES1 - ES2 - OFF1 - OFF2 - LL1 - LL2 - noCRO - noSTD1- noSTD2
DI16	10	20	20	Pr1	Delay of configurable digital input 1	0 ÷ 255 (min)
DI17	CL	CL	CL	Pr1	Polarity of configurable digital input 2	OP - CL
DI18	ES1	ES1	ES1	Pr1	Function of configurable digital input 2	ES1 - ES2 - OFF1 - OFF2 - LL1 - LL2 - noCRO - noSTD1- noSTD2

Nome	XC 1008D	XC 1011D	XC 1015D	Level	Description	Range
DI19	0	0	0	Pr1	Delay of configurable digital input 2	0 + 255 (min)
DI20	CL	CL	CL	Pr1	Polarity of configurable digital input 3	OP - CL
DI21	LL2	LL2	LL2	Pr1	Function of configurable digital input 3	ES1 - ES2 - OFF1 - OFF2 - LL1 - LL2 - noCRO - noSTD1- noSTD2
DI22	0	20	20	Pr1	Delay of configurable digital input 3	0 + 255 (min)
DI23	CL	CL	CL	Pr1	Polarity of configurable digital input 4	OP - CL
DI24	ES2	ES2	ES2	Pr1	Function of configurable digital input 4	ES1 - ES2 - OFF1 - OFF2 - LL1 - LL2 - noCRO - noSTD1- noSTD2
DI25	0	0	0	Pr1	Delay of configurable digital input 4	0 + 255 (min)
DI26	ALr	ALr	ALr	Pr1	Relay for LL alarm - circuit 1	nu - ALr - ALr1 - ALr2
DI27	-	ALr	ALr	Pr1	Relay for LL alarm - circuit 2	nu - ALr - ALr1 - ALr2
CP1	4.0	4.0	4.0	Pr1	Regulation band width circuit 1	^(BAR) 0.10÷10.00 ^(°C) 0.0+25.0 ^(PSI) 1+80 ^(°F) 1+50
CP2	-40,0	-40,0	-40,0	Pr1	Minimum set point circuit 1	BAR: (A12 + SETC1); °C: (-50.0 + SETC1); PSI : (A12 + SETC1); °F : (-58.0 + SETC1)
CP3	10,0	10.0	10.0	Pr1	Maximum set point circuit 1	BAR: (SETC1+A13); °C : (SETC1 + 150.0); PSI : (SETC1 + A13); °F: (SETC1 + 302)
CP4	0	0.0	0.0	Pr1	Energy saving circuit 1	^(BAR) -20.00+20.00 ^(°C) -50.0+50.0 ^(PSI) -300+300 ^(°F) -90+90
CP5	-	5.0	5.0	Pr1	Regulation band width circuit 2	^(BAR) 0.10÷10.00 ^(°C) 0.0+25.0 ^(PSI) 1+80 ^(°F) 1+50
CP6	-	-40,0	-40,0	Pr1	Minimum set point circuit 2	BAR: (A15 + SETC2); °C: (-50.0 + SETC2); PSI : (A15 + SETC2); °F : (-58.0 + SETC2)
CP7	-	10.0	10.0	Pr1	Maximum set point circuit 2	BAR: (SETC2+A16); °C : (SETC2 + 150.0); PSI : (SETC2 + A16); °F: (SETC2 + 302)
CP8	-	0.0	0.0	Pr1	Energy saving circuit 2	^(BAR) -20.00+20.00 ^(°C) -50.0+50.0 ^(PSI) -300+300 ^(°F) -90+90
CP9	5	5	5	Pr1	2 start compressor delay	0 + 255 (min)
CP10	2	2	2	Pr1	Minimum time load off	0 + 255 (min)
CP11	15	15	15	Pr1	2 different load start delay	0 + 99.5 (min.1sec)
CP12	5	5	5	Pr1	2 different load off delay	0 + 99.5 (min.1sec)
CP13	15	15	15	Pr1	Minimum time load on	0 + 99.5 (min.1sec)
CP14	0	nu	nu	Pr1	Maximum time load on (0=nu)	0 + 24 (h) - with 0 the function is disabled
CP15	0	0	0	Pr1	Min time Frq1-2 off after CP14	0 + 255 (min)
CP16	no	NO	NO	Pr1	CP11 enabled also at first on	no - YES
CP17	no	NO	NO	Pr1	CP12 enabled also at first off	no - YES
CP18	10	10	10	Pr1	Output delay at power on	0 + 255 (sec)
CP19	-	NO	NO	Pr2	Booster function enabled	no - YES
F1	4,0	4.0	4.0	Pr1	Regulation band width circuit 1	^(BAR) 0.10÷10.00 ^(°C) 0.0+30.0 ^(PSI) 1+80 ^(°F) 1+50.0
F2	10,0	10.0	10.0	Pr1	Minimum set point circuit 1	BAR: (A19 + SETF1); °C: (-50.0 + SETF1); PSI : (A19 + SETF1); °F : (-58.0 + SETF1)
F3	60,0	60.0	60.0	Pr1	Maximum set point circuit 1	BAR: (SETF1+A110); °C : (SETF1 + 150.0); PSI : (SETF1 + A110); °F: (SETF1 + 302)
F4	0,0	0.0	0.0	Pr1	Energy saving circuit 1	^(BAR) -20.00+20.00 ^(°C) -50.0+50.0 ^(PSI) -300+300 ^(°F) -90+90
F5	-	4.0	4.0	Pr1	Regulation band width circuit 2	^(BAR) 0.10÷10.00 ^(°C) 0.0+30.0 ^(PSI) 1+80 ^(°F) 1+50.0
F6	-	10.0	10.0	Pr1	Minimum set point circuit 2	BAR: (A112 + SETF2); °C: (-50.0 + SETF2); PSI : (A112 + SETF2); °F : (-58.0 + SETF2)
F7	-	60.0	60.0	Pr1	Maximum set point circuit 2	BAR: (SETF2+A113); °C : (SETF2 + 150.0); PSI : (SETF2 + A113); °F: (SETF2 + 302)
F8	-	0.0	0.0	Pr1	Energy saving circuit 2	^(BAR) -20.00+20.00 ^(°C) -50.0+50.0 ^(PSI) -300+300 ^(°F) -90+90
F9	15	15	15	Pr1	2 different fan start delay	1 + 255 (sec)
F10	5	5	5	Pr1	2 different fan off delay	1 + 255 (sec)

Nome	XC 1008D	XC 1011D	XC 1015D	Level	Description	Range
HS1	nu	nu	nu	Pr1	Energy Saving start time on Monday	0:0+23.5h; nu
HS2	00,00	00:00	00:00	Pr1	Monday Energy Saving duration	0:0+23.5h;
HS3	nu	nu	nu	Pr1	Energy Saving start time on Tuesday	0:0+23.5h; nu
HS4	00,00	00:00	00:00	Pr1	Tuesday Energy Saving duration	0:0+23.5h;
HS5	nu	nu	nu	Pr1	Energy Saving start time on Wednesday	0:0+23.5h; nu
HS6	00,00	00:00	00:00	Pr1	Wednesday Energy Saving duration	0:0+23.5h;
HS7	nu	nu	nu	Pr1	Energy Saving start time on Thursday	0:0+23.5h; nu
HS8	00,00	00:00	00:00	Pr1	Thursday Energy Saving duration	0:0+23.5h;
HS9	nu	nu	nu	Pr1	Energy Saving start time on Friday	0:0+23.5h; nu
HS10	00,00	00:00	00:00	Pr1	Friday Energy Saving duration	0:0+23.5h;
HS11	nu	nu	nu	Pr1	Energy Saving start time on Saturday	0:0+23.5h; nu
HS12	00,00	00:00	00:00	Pr1	Saturday Energy Saving duration	0:0+23.5h;
HS13	nu	nu	nu	Pr1	Energy Saving start time on Sunday	0:0+23.5h; nu
HS14	00,00	00:00	00:00	Pr1	Sunday Energy Saving duration	0:0+23.5h;
AC1	30	30	30	Pr1	Probe 1 alarm delay at power on	0 + 255 (min)
AC2	-	30	30	Pr1	Probe 2 alarm delay at power on	0 + 255 (min)
AC3	15,0	15.0	15.0	Pr1	Minimum temp/press alarm circuit 1	(0.10 + 30.00) ^{BAR} (0.0 + 100.0) ^{°C} (1 + 430) ^{PSI} (1 + 200.0) ^{°F} AC0 = ABS: -1.00 to AC4bar; -50 to AC4°C; -14 to AC4 PSI; -58 to AC4°F; -100 to AC4 KPA
AC4	20,0	20.0	20.0	Pr1	Maximum temp/press alarm circuit 1	With AC0 = REL: 0.10 to 30.00bar; 0.0 to 100.0°C; 1 to 430 PSI; 1 to 200.0°F; 10 to 3000KPA With AC0 = ABS: AC3 to 100.00bar; AC3 to 150°C; -AC3 to 1450 PSI; AC3 to 230°F; AC3 to 10000 KPA
AC5	20	20	20	Pr1	Temp/press alarm delay circuit 1	0 + 255 (min)
AC6	-	15.0	15.0	Pr1	Minimum temp/press alarm circuit 2	With AC0 = REL: 0.10 to 30.00bar; 0.0 to 100.0°C; 1 to 430 PSI; 1 to 200.0°F; 10 to 3000KPA With AC0 = ABS: -1.00 to AC7bar; -50 to AC7°C; -14 to AC7 PSI; -58 to AC7°F; -100 to AC7 KPA
AC7	-	20.0	20.0	Pr1	Maximum temp/press alarm circuit 2	With AC0 = REL: 0.10 to 30.00bar; 0.0 to 100.0°C; 1 to 430 PSI; 1 to 200.0°F; 10 to 3000KPA With AC0 = ABS: AC6 to 100.00bar; AC6 to 150°C; -AC6 to 1450 PSI; AC6 to 230°F; AC6 to 10000 KPA
AC8	-	20	20	Pr1	Temp/press alarm delay circuit 2	0 + 255 (min)
AC9	ALr	ALr	ALr	Pr1	Relay for temp/press alarm	nu - ALr - ALr1 - ALr2
AC10	20000	20000	20000	Pr1	Running hours for maintenance	0 + 25000 – with 0 the function is disabled
AC11	ALr	ALr	ALr	Pr1	Relay for maintenance alarm	nu - ALr - ALr1 - ALr2
AC12	15	15	15	Pr1	LP switch 1 activation number	0 + 15
AC13	15	15	15	Pr1	LP switch 1 activation time	0 + 255 (min)
AC14	2	2	2	Pr1	Compressure on-faulty probe1	0 + 15
AC16	-	15	15	Pr1	LP switch 2 activation number	0 + 15
AC17	-	15	15	Pr1	LP switch 2 activation time	0 + 255 (min)
AC18	-	2	2	Pr1	Compressure on-faulty probe2	0 + 15
AC20	YES	YES	YES	Pr2	Electronic pressure switch activation for circuit 1	no(0) - yES(1)
AC21	-50.0	-50.0	-50.0	Pr2	Pressure/temperature threshold of compressor set for circuit 1	BAR: (AI2 to SETC1); °C: (-50.0 to SETC1); PSI: (AI2 to SETC1); °F: (-58.0 to SETC1);

Nome	XC 1008D	XC 1011D	XC 1015D	Level	Description	Range
						KPA: (AI2 to SETC1);
AC22	YES	YES	YES	Pr2	Electronic pressure switch activation for circuit 2	no(0) - yES(1)
AC23	-50.0	-50.0	-50.0	Pr2	Pressure/temperature threshold of compressor set for circuit 2	BAR: (AI5 to SETC2); °C: (-50.0 to SETC2); PSI : (AI5 to SETC2); °F : (-58.0 to SETC2); KPA: (AI5 to SETC2);
AF1	20.0	20.0	20.0	Pr1	Minimum temp/press alarm circuit 1	With AF0 = REL: 0.10 to 30.00bar; 0.0 to 100.0°C; 1 to 430 PSI; 1 to 200.0°F; 10 to 3000KPA With AF0 = ABS: -1.00 to AF2bar; -50 to AF2°C; -14 to AF2PSI; -58 to AF2°F; -100 to AF2KPA
AF2	20.0	20.0	20.0	Pr1	Maximum temp/press alarm circuit 1	With AF0 = REL 0.10 to 30.00bar; 0.0 to 100.0°C; 1 to 430 PSI; 1 to 200.0°F; 10 to 3000KPA With AF0 = ABS: AF1 to 100.00bar; AF1 to 150°C; AF1 to 1450 PSI; AF1 to 230°F; AF1 to 10000 KPA
AF3	20	20	20	Pr1	Temp/press alarm delay circuit 1	0 ÷ 255 (min)
AF4	no	NO	NO	Pr1	Compressor off with max alarm 1	no - YES
AF5	2	2	2	Pr1	Off delay with max alarm 1	0 ÷ 255 (min)
AF6	15	15	15	Pr1	HP switch 1 activation number	0 ÷ 15
AF7	15	15	15	Pr1	HP switch 1 activation time	0 ÷ 255 (min)
AF8	2	2	2	Pr1	Fans on with faulty probe 3	0 ÷ 15
AF9	-	20.0	20.0	Pr1	Minimum temp/press alarm circuit 2	$(0.10 \div 30.00)^{BAR} (0.0 \div 100.0)^{C} (1 \div 430)^{PSI} (1 \div 200.0)^{F}$
AF10	-	20.0	20.0	Pr1	Maximum temp/press alarm circuit 2	$(0.10 \div 30.00)^{BAR} (0.0 \div 100.0)^{C} (1 \div 430)^{PSI} (1 \div 200.0)^{F}$
AF11	-	20	20	Pr1	Temp/press alarm delay circuit 2	0 ÷ 255 (min)
AF12	-	NO	NO	Pr1	Compressor off with max alarm 2	no - YES
AF13	-	2	2	Pr1	Off delay with max alarm 2	0 ÷ 255 (min)
AF14	-	15	15	Pr1	HP switch 2 activation number	0 ÷ 15
AF15	-	15	15	Pr1	HP switch 2 activation time	0 ÷ 255 (min)
AF16	-	2	2	Pr1	Fans on with faulty probe 3	0 ÷ 15
AF17	ALr	ALr	ALr	Pr1	Relay for temp/press alarm	nu - ALr - ALr1 - ALr2
O1	no	NO	NO	Pr2	Dynamic set enabled - circuit 1	no - YES
O2	-18.0	-18.0	-18.0	Pr2	Maximum set for circuit 1	SETC1+CP3
O3	15.0	15.0	15.0	Pr2	Dynamic set start temperature circuit 1	-40+04 °C /-40+04°F
O4	15.0	15.0	15.0	Pr2	Dynamic set stop temperature circuit 1	O3+150°C /O3+302°F
O5	-	NO	NO	Pr2	Dynamic set enabled - circuit 2	no - YES
O6	-	-18.0	-18.0	Pr2	Maximum set for circuit 2	SETC2+CP7
O7	-	15.0	15.0	Pr2	Dynamic set start temperature circuit 2	-40+08°C /-40+08°F
O8	-	15.0	15.0	Pr2	Dynamic set stop temperature circuit 2	O7+150°C /O7+302°F
O9	no	NO	NO	Pr2	Dynamic set enabled - circuit 1	no - YES
O10	25.0	25.0	25.0	Pr2	Minimum condens. set - circuit 1	F2+SETF1
O11	15	15.0	15.0	Pr2	Differential dynamic set-circuit 1	(BAR) -20.00+20.00 (°C) -50.0+50.0 (PSI) -300+300 (°F) -90+90
O12	-	NO	NO	Pr2	Dynamic set enabled - circuit 2	no - YES
O13	-	25.0	25.0	Pr2	Minimum condens. set - circuit 2	F6+SETF2
O14	-	15.0	15.0	Pr2	Differential dynamic set-circuit 2	(BAR) -20.00+20.00 (°C) -50.0+50.0 (PSI) -300+300 (°F) -90+90
1Q1	4.20mA	4.20mA	4.20mA	Pr1	Analog outputs 1-2 setting	4.20 mA (0) - 0.10 V (1)
1Q2	nu	nu	nu	Pr1	Analog output 1 function	FREE - CPR - CPR2 - FAN - FAN2 - INVf1 - INVf2 - nu

Nome	XC 1008D	XC 1011D	XC 1015D	Level	Description	Range
1Q3	Pbc1	Pbc1	Pbc1	Pr1	Probe for analog output 1	Pbc1(0) - Pbc2(1) ; used only with 1Q2 = 0
1Q4	0.0	0.0	0.0	Pr1	Lower limit for analog output 1	-1+100.00 bar; -15+750PSI; -50+150°C; -58+302°F;
1Q5	100.0	100.0	100.0	Pr1	Upper limit for analog output 1	-1+100.00 bar; -15+750PSI; -50+150°C; -58+302°F;
1Q6	30	50	50	Pr1	Minimum value for analog output 1	0 + 100 %
1Q7	40	50	50	Pr1	Analog output 1 value after compressor start	1Q6 ÷ 100 %
1Q8	40	60	60	Pr1	Analog output 1 value after compressor off	1Q6 ÷ 100 %
1Q9	40	50	50	Pr1	Exclusion band start value 1	1Q7 + 100 %
1Q10	40	50	50	Pr1	Exclusion band end value 1	1Q9 + 100 %
1Q11	50	50	50	Pr1	Safety value for Analog output 1	0 + 100 (%)
1Q12	0	0	0	Pr1	Regulation delay after exit from neutral zone	0 + 255 (sec)
1Q13	60	60	60	Pr1	Analog output 1 rise time	0 + 255 (sec)
1Q14	10	10	10	Pr1	Analog output 1 permanency before load activation	0 + 255 (sec)
1Q15	0	2	2	Pr1	Analog output 1 decreasing delay	0 + 255 (sec)
1Q16	150	5	5	Pr1	Analog output 1 decreasing time	0 + 255 (sec)
1Q17	10	5	5	Pr1	Analog output 1 permanency before load off	0 + 255 (sec)
1Q18	5	5	5	Pr1	Analog output 1 decreasing time after load off	0 + 255 (sec)
1Q19	4.0	4.0	4.0	Pr1	Regulation band width 1	0.10+25.00bar; 0.0+25.0°C; 1+250 PSI; 1+250°F;10+2500 KPA
1Q20	350	350	350	Pr1	Integral time 1	0+999s; with 0 integral action excluded
1Q21	0.0	0.0	0.0	Pr1	Band offset 1	(-12.0+12.0°C -12.00 ÷ 12.00BAR, -120+120°F, -120+120PSI; -1200+1200KPA
1Q22	4.0	4.0	4.0	Pr1	Anti reset wind-up 1	0.0+99.0 °C; 0+180°F; 0.00+50.00bar; 0+725PSI; 0+5000kPA
1Q24	0	0	0	Pr1	Minimum capacity of inverter 1	0+99%; with 0 function excluded
1Q25	255	255	255	Pr1	Maximum time at minimum capacity of inverter 1	1+255min
1Q26	2	2	2	Pr1	Time at maximum capacity of inverter 1	1+255min
2Q1	-	nu	nu	Pr1	Analog output 2 function	FREE – CPR - CPR2 - FAN - FAN2 - INVF1 - INVF2 - nu
2Q2	-	Pbc2	Pbc2	Pr1	Probe for analog output 2	Pbc1(0) - Pbc2(1) ; usata solo quando 2Q2 = 0
2Q3	-	0.0	0.0	Pr1	Lower limit for analog output 2	-1+100.00 bar; -15+750PSI; -50+150°C; -58+302°F;
2Q4	-	100.0	100.0	Pr1	Upper limit for analog output 2	-1+100.00 bar; -15+750PSI; -50+150°C; -58+302°F;
2Q5	-	50	50	Pr1	Minimum value for analog output 2	0 + 100 (%)
2Q6	-	50	50	Pr1	Analog output 2 value after compressor start	2Q5 + 100 %
2Q7	-	60	60	Pr1	Analog output 2 value after compressor off	2Q5 + 100 %
2Q8	-	50	50	Pr1	Exclusion band start value 2	2Q6 ÷ 100 %
2Q9	-	50	50	Pr1	Exclusion band end value 2	2Q8 ÷ 100 %
2Q10	-	50	50	Pr1	Safety value for Analog output 2	0 + 100 (%)
2Q11	-	0	0	Pr1	Regulation delay after exit from neutral zone	0 + 255 (sec)
2Q12	-	60	60	Pr1	Analog output 2 rise time	0 + 255 (sec)
2Q13	-	10	10	Pr1	Analog output 2 permanency before load activation	0 + 255 (sec)
2Q14	-	2	2	Pr1	Analog output 2 decreasing delay	0 + 255 (sec)
2Q15	-	5	5	Pr1	Analog output 2 decreasing time	0 + 255 (sec)

Nome	XC 1008D	XC 1011D	XC 1015D	Level	Description	Range
2Q16	-	5	5	Pr1	Analog output 2 permanency before load off	0 ÷ 255 (sec)
2Q17	-	5	5	Pr1	Analog output 2 decreasing time after load off	0 ÷ 255 (sec)
2Q18	-	4.0	4.0	Pr1	Regulation band width 2	0.10÷25.00bar; 0.0÷25.0°C; 1÷250 PSI; 1÷250°F; 10÷2500 KPA
2Q19	-	350	350	Pr1	Integral time 2	0÷999s; with 0 integral action excluded
2Q20	-	0.0	0.0	Pr1	Band offset 2	-12.0÷12.0°C -12.00 ÷ 12.00BAR, -120÷120°F, -120÷120PSI; -1200÷1200KPA
2Q21	-	4.0	4.0	Pr1	Anti reset wind-up 2	0.0÷99.0 °C; 0÷180°F; 0.00÷50.00bar; 0÷725PSI; 0÷5000kPA
2Q23	-	0	0	Pr1	Minimum capacity of inverter 2	0÷99%; with 0 function excluded
2Q24	-	255	255	Pr1	Maximum time at minimum capacity of inverter 2	1÷255min
2Q25	-	2	2	Pr1	Time at maximum capacity of inverter 2	1÷255min
3Q1	4.20mA	4.20mA	4.20mA	Pr1	Analog outputs 3-4 setting	4.20 mA (0) - 0.10 V (1)
3Q2	nu	nu	nu	Pr1	Analog output 3 function	FREE – CPR - CPR2 - FAN - FAN2 - INVF1 - INVF2 - nu
3Q3	Pbc3	Pbc3	Pbc3	Pr1	Probe for analog output 3	Pbc3(0); Pbc4(1); used with 3Q2 = 0
3Q4	0.0	0.0	0.0	Pr1	Lower limit for analog output 3	-1÷100.00 bar; -15÷750PSI; -50÷150°C; -58÷302°F;
3Q5	100.0	100.0	100.0	Pr1	Upper limit for analog output 3	-1÷100.00 bar; -15÷750PSI; -50÷150°C; -58÷302°F;
3Q6	30	50	50	Pr1	Minimum value for analog output 3	0 ÷ 100 (%)
3Q7	40	50	50	Pr1	Analog output 3 value after fan start	3Q6 ÷ 100 %
3Q8	40	70	70	Pr1	Analog output 3 value after fan off	3Q6 ÷ 100 %
3Q9	40	50	50	Pr1	Exclusion band start value 3	3Q7 ÷ 100 %
3Q10	40	50	50	Pr1	Exclusion band end value 3	3Q9 ÷ 100 %
3Q11	50	50	50	Pr1	Safety value for Analog output 3	0 ÷ 100 (%)
3Q12	0	0	0	Pr1	Regulation delay after exit from neutral zone	0 ÷ 255 (sec)
3Q13	60	60	60	Pr1	Analog output 3 rise time	0 ÷ 255 (sec)
3Q14	10	10	10	Pr1	Analog output 3 permanency before load activation	0 ÷ 255 (sec)
3Q15	0	0	0	Pr1	Analog output 3 decreasing delay	0 ÷ 255 (sec)
3Q16	150	15	15	Pr1	Analog output 3 decreasing time	0 ÷ 255 (sec)
3Q17	10	5	5	Pr1	Analog output 3 permanency before load off	0 ÷ 255 (sec)
3Q18	5	5	5	Pr1	Analog output 3 decreasing time after load off	0 ÷ 255 (sec)
3Q19	4.0	4.0	4.0	Pr1	Regulation band width 3	0.10÷25.00bar; 0.0÷25.0°C; 1÷250 PSI; 1÷250°F; 10÷2500 KPA
3Q20	500	500	500	Pr1	Integral time 3	0÷999s; with 0 integral action excluded
3Q21	0.0	0.0	0.0	Pr1	Band offset 3	(-12.0÷12.0°C -12.00 ÷ 12.00BAR, -120÷120°F, -120÷120PSI; -1200÷1200KPA
3Q22	4.0	4.0	4.0	Pr1	Anti reset wind-up 3	0.0÷99.0 °C; 0÷180°F; 0.00÷50.00bar; 0÷725PSI; 0÷5000kPA
3Q24	0	0	0	Pr1	Minimum capacity of inverter 3	0÷99%; with 0 function excluded
3Q25	255	255	255	Pr1	Maximum time at minimum capacity of inverter 3	1÷255min
3Q26	2	2	2	Pr1	Time at maximum capacity of inverter 3	1÷255min
4Q1	-	nu	nu	Pr1	Analog output 4 function	FREE – CPR - CPR2 - FAN - FAN2 - INVF1 - INVF2 - nu
4Q2	-	Pbc4	Pbc4	Pr1	Probe for analog output 4	Pbc3(0); Pbc4(1); used with 4Q1 = 0
4Q3	-	0.0	0.0	Pr1	Lower limit for analog output 4	-1÷100.00 bar; -15÷750PSI; -50÷150°C; -58÷302°F;

Nome	XC 1008D	XC 1011D	XC 1015D	Level	Description	Range
4Q4	-	100.0	100.0	Pr1	Upper limit for analog output 4	-1+100.00 bar; -15+750PSI; -50+150°C; -58+302°F;
4Q5	-	50	50	Pr1	Minimum value for analog output 4	0 ÷ 100 (%)
4Q6	-	50	50	Pr1	Analog output 4 value after fan start	4Q5+ 100 %
4Q7	-	70	70	Pr1	Analog output 4 value after fan off	4Q5+ 100 %
4Q8	-	50	50	Pr1	Exclusion band start value 4	4Q6 ÷ 100 %
4Q9	-	50	50	Pr1	Exclusion band end value 4	4Q8 ÷ 100 %
4Q10	-	50	50	Pr1	Safety value for Analog output 4	0 ÷ 100 (%)
4Q11	-	0	0	Pr1	Regulation delay after neutral zone exit	0 ÷ 255 (sec)
4Q12	-	60	60	Pr1	Analog output 4 rise time	0 ÷ 255 (sec)
4Q13	-	10	10	Pr1	Analog output 4 permanency before load activation	0 ÷ 255 (sec)
4Q14	-	0	0	Pr1	Analog output 4 decreasing delay	0 ÷ 255 (sec)
4Q15	-	15	15	Pr1	Analog output 4 decreasing time	0 ÷ 255 (sec)
4Q16	-	5	5	Pr1	Analog output 4 perm before load off	0 ÷ 255 (sec)
4Q17	-	5	5	Pr1	Analog output 4 decreasing time after load off	0 ÷ 255 (sec)
4Q18	-	4.0	4.0	Pr1	Regulation band width 4	0.10+25.00bar; 0.0+25.0°C; 1+250 PSI; 1+250°F;10+2500 KPA
4Q19	-	500	500	Pr1	Integral time 4	0+999s; with 0 integral action excluded
4Q20	-	0.0	0.0	Pr1	Band offset 4	(-12.0+12.0°C -12.00 ÷ 12.00BAR, -120+120°F, -120+120PSI; -1200+1200KPA
4Q21	-	4.0	4.0	Pr1	Anti reset wind-up 4	0.0+99.0 °C; 0+180°F; 0.00+50.00bar; 0+725PSI; 0+5000kPA
4Q23	-	0	0	Pr1	Minimum capacity of inverter 4	0+99%; with 0 function excluded
4Q24	-	255	255	Pr1	Maximum time at minimum capacity of inverter 4	1+255min
4Q25	-	2	2	Pr1	Time at maximum capacity of inverter 4	1+255min
AR1	0,0	0,0	0,0	0,0	Set point aux relay 1	-40+110°C/-40+230°F
AR2	1,0	1,0	1,0	1,0	Differential for aux relay 1	0,1+25,0°C/1+50°F
AR3	CL	CL	CL	CL	Kind of action for aux 1	CL = cooling; Ht = heating
AR4	0,0	0,0	0,0	0,0	Set point aux relay 2	-40+110°C/-40+230°F
AR5	1,0	1,0	1,0	1,0	Differential for aux relay 2	0,1+25,0°C/1+50°F
AR6	CL	CL	CL	CL	Kind of action for aux 2	CL = cooling; Ht = heating
AR7	0,0	0,0	0,0	0,0	Set point aux relay 3	-40+110°C/-40+230°F
AR8	1,0	1,0	1,0	1,0	Differential for aux relay 3	0,1+25,0°C/1+50°F
AR9	CL	CL	CL	CL	Kind of action for aux 3	CL = cooling; Ht = heating
AR10	0,0	0,0	0,0	0,0	Set point aux relay 4	-40+110°C/-40+230°F
AR11	1,0	1,0	1,0	1,0	Differential for aux relay 4	0,1+25,0°C/1+50°F
AR12	CL	CL	CL	CL	Kind of action for aux 4	CL = cooling; Ht = heating
ASH0					Differential of superheat prealarm 1 and 2	0.1 to 15.0°C/ 1 to 30°F
ASH1	15.0	15.0	15.0	Pr2	Bottom limit of suction superheat alarm 1	0.1 to 15.0°C/ 1 to 30°F
ASH2					Delay for signalling the suction superheat alarm 1	0 to 60 min
ASH3	10	10	10	Pr2	Switching off compressors for alarm ASH1	No, Yes
ASH4	NO	NO	NO	Pr2	Differential for restarting suction superheat alarm control 1	0.1 to 15.0°C/ 1 to 30°F
ASH5	5.0	5.0	5.0	Pr2	Delay for restarting control after superheat > ASH1+ASH4	0 to 60 min
ASH6	2	2	2	Pr2	Superheat value 1 at which to enable valve 1 for injecting hot gas (hot action)	0.1 to 15.0°C/ 1 to 30°F
	15.0	15.0	15.0	Pr2		

Nome	XC 1008D	XC 1011D	XC 1015D	Level	Description	Range
ASH7	3.0	3.0	3.0	Pr2	Differential for ASH6	0.1 to 15.0°C/ 1 to 30°F
ASH8	-	15.0	15.0	Pr2	Bottom limit of suction superheat alarm 2	0.1 to 15.0°C/ 1 to 30°F
ASH9	-	10	10	Pr2	Delay for signalling suction superheat alarm 2	0 to 60 min
ASH10	-	NO	NO	Pr2	Switching off compressors for alarm ASH8	No, Yes
ASH11	-	5.0	5.0	Pr2	Differential for restarting suction superheat alarm control 2	0.1 to 15.0°C/ 1 to 30°F
ASH12	-	2	2	Pr2	Delay for restarting control after superheat > ASH8+ASH11	0 to 60 min
ASH13	-	15.0	15.0	Pr2	Superheat value 2 at which to enable valve 2 for injecting hot gas (hot action)	0.1 to 15.0°C/ 1 to 30°F
ASH14	-	3.0	3.0	Pr2	Differential for ASH13	0.1 to 15.0°C/ 1 to 30°F
ASH15	ALr	ALr	ALr	Pr2	Activation of alarm relay for superheat alarms	nu(0) - ALr(1) - ALr1(2) - ALr2(3)
OT1	yES	yES	yES	yES	Alarm relay off by keyboard	no - YES
OT2	CL	CL	CL	CL	Alarm relay polarity	OP - CL
OT3	yES	yES	yES	yES	Alarm relay 1 off by keyboard	no - YES
OT4	OP	OP	OP	OP	Alarm relay 1 polarity	OP - CL
OT5	yES	yES	yES	yES	Alarm relay 2 off by keyboard	no - YES
OT6	OP	OP	OP	OP	Alarm relay 2 polarity	OP - CL
OT7	1	1	1	1	Serial address	1 ÷ 247
OT9	NO	NO	NO	NO	Off function enabling	no - YES

Dixell



Dixell S.r.l. - Z.I. Via dell'Industria, 27 - 32010 Alpago (BL) ITALY
Tel. +39.0437.9833 r.a. - Fax +39.0437.989313 - EmersonClimate.com/Dixell - dixell@emerson.com