

ASH-09BIS2W indoor

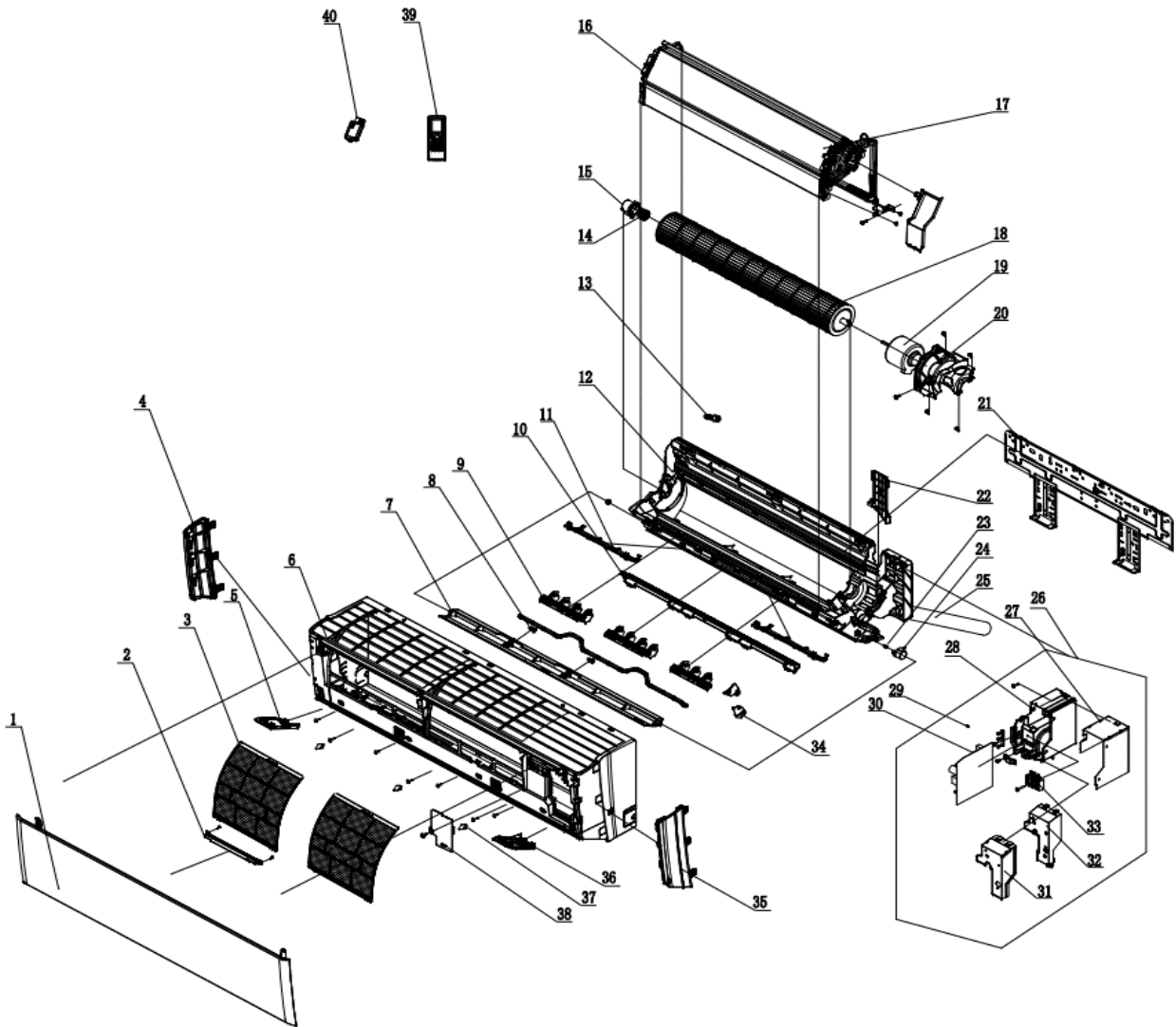

No	Description	Part Code	Note	Qty	Price Code
MODEL: ASH-09BIS2/W (INDOOR)					
1	Front Panel Assy	00000300008303_L41423		1	-
2	Display Board	300001000095		1	AR
3	Filter Sub-Assy	11122089		2	AD
4	Left Side Plate	20008500004		1	AD
5	Decorative Board (Left)	23000500010		1	AB
6	Front Case Assy	00000200060		1	AT
7	Guide Louver	10512501		1	AM
8	Axile Bush	10542036		2	AB
9	Air Louver	10512736		1	AB
10	Helicoid Tongue	26112512		1	AE
11	Rear Grill Sub-assy	none		0	-
12	Rear Case assy	00000100177		1	AX
13	Rubber Plug (Water Tray)	76712012		1	AC
14	O-Gasket sub-assy of Bearing	76512051		1	AC
15	Ring of Bearing	26152025		1	AC
16	Evaporator Support	24212177		1	AE
17	Evaporator Assy	01100100047201		1	BE
18	Cross Flow Fan	10352060		1	AN
19	Fan Motor	15012136		1	BC
20	Motor Press Plate	26112511		1	AE
21	Wall Mounting Frame	01362026		1	AK
22	Connecting pipe clamp	2611218801		1	AB
23	Crank	73012005		1	AB
24	Stepping Motor	1521240212		1	AG
25	Drainage Hose	05230014		1	AD
26	Electric Box Assy	100002004024		1	BB
27	Lower Shield of Electric Box	01592139		1	AD
28	Electric Box	2011221102		1	AL
29	Jumper	4202021911		1	AA
30	Main Board	300002000858		1	AZ
31	Shield Cover of Electric Box	01592176		1	AD
32	Electric Box Cover	20112209		1	AD
33	Terminal Board	42011233		1	AE
34	Stepping Motor	1521210704		1	AG
35	Right Side Plate	20008600005		1	AD
36	Decorative Board (Right)	23000500011		1	AB
37	Screw Cover	2425201726		3	AB
38	Electric Box Cover2	20112210		1	AD
39	Remote Controller	305001000139_L41423		1	-
40	Test Board Assy	000409000001_L41423		1	AU
	Remote Holder	26150008			
	Temperature Sensor	3900031302			

The data are subject to change without notice.