

MV-E36BI2

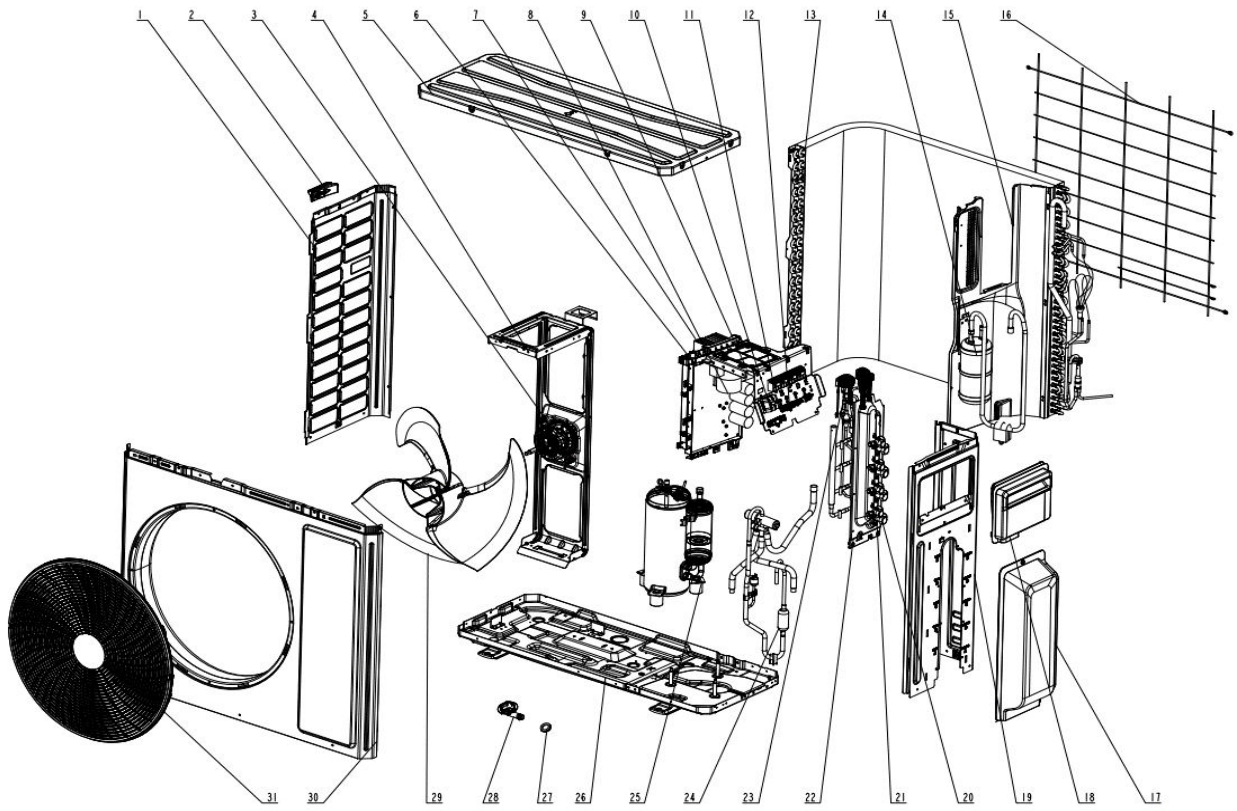

No	Description	Part Code	Note	Qty	Price Code
MODEL: MV-E36BI2					
1	Left Side Plate	012055060419P		1	
2	Handle	26233053		1	
3	Brushless DC Motor	15010406011801		1	
4	Motor Support Sub-Assy	017012060353		1	
5	Top cover	012049060148P		1	
6	Electric Box Assy	100002075584		1	
7	Radiator	430034060159		1	
8	Main Board	300027062550		1	
9	Filter Board	300020060099		1	
10	Terminal Board	422000060012		1	
11	Terminal Board	422000060015		4	
12	Wire Clamp	200015060018		1	
13	Condenser Assy	011002062063		1	
14	Gas-liquid Separator Assy	07225017		1	
15	Clapboard	012051061706		1	
16	Rear Grill	016001060101		1	
17	Valve Cover	200087060009		1	
18	Handle	200149060029		1	
19	Right Side Plate	012056060565P		1	
20	Cut off Valve Sub-Assy(1/4)	030057060367		4	
21	Cut off Valve Sub-Assy(3/8)	030057060366		4	
22	Valve Support Sub-Assy	017104060062P		1	
23	Electronic Expansion Valve assy	030174060252		1	
24	4-Way Valve Assy	030152060946		1	
25	Compressor and Fittings	009001060896		1	
26	Chassis Sub-assy	017000060846P		1	
27	Drainage hole Cap	06813401		4	
28	Drainage Joint	26113009		1	
29	Axial Flow Fan	1043410000501		1	
30	Cabinet	012022060021P		1	
31	Front Grill	200057060031		1	

The data are subject to change without notice.