

Conex | Bänninger

>B< MaxiPro

Join the Press Revolution

Air Conditioning and Refrigeration



>B< MaxiPro Technical Brochure

Inch (1/4-1 3/8") and Metric (6-28 mm)

Join the Press Revolution

110 years of innovation

Conex Bänninger specialises in providing fittings, valves and accessories across the globe by offering innovative and versatile solutions. Since 1909, Conex Bänninger has produced over 22 billion fittings and valves and has built its reputation for quality European manufacturing, backed by first-class customer service and unrivalled expertise.

Passionate about excellence, Conex Bänninger is a byword for quality in the domestic, commercial, industrial, shipbuilding, air conditioning and refrigeration markets worldwide. Conex Bänninger is an ISO 9001 company, which assures their customers of consistency in the quality of their services and products.



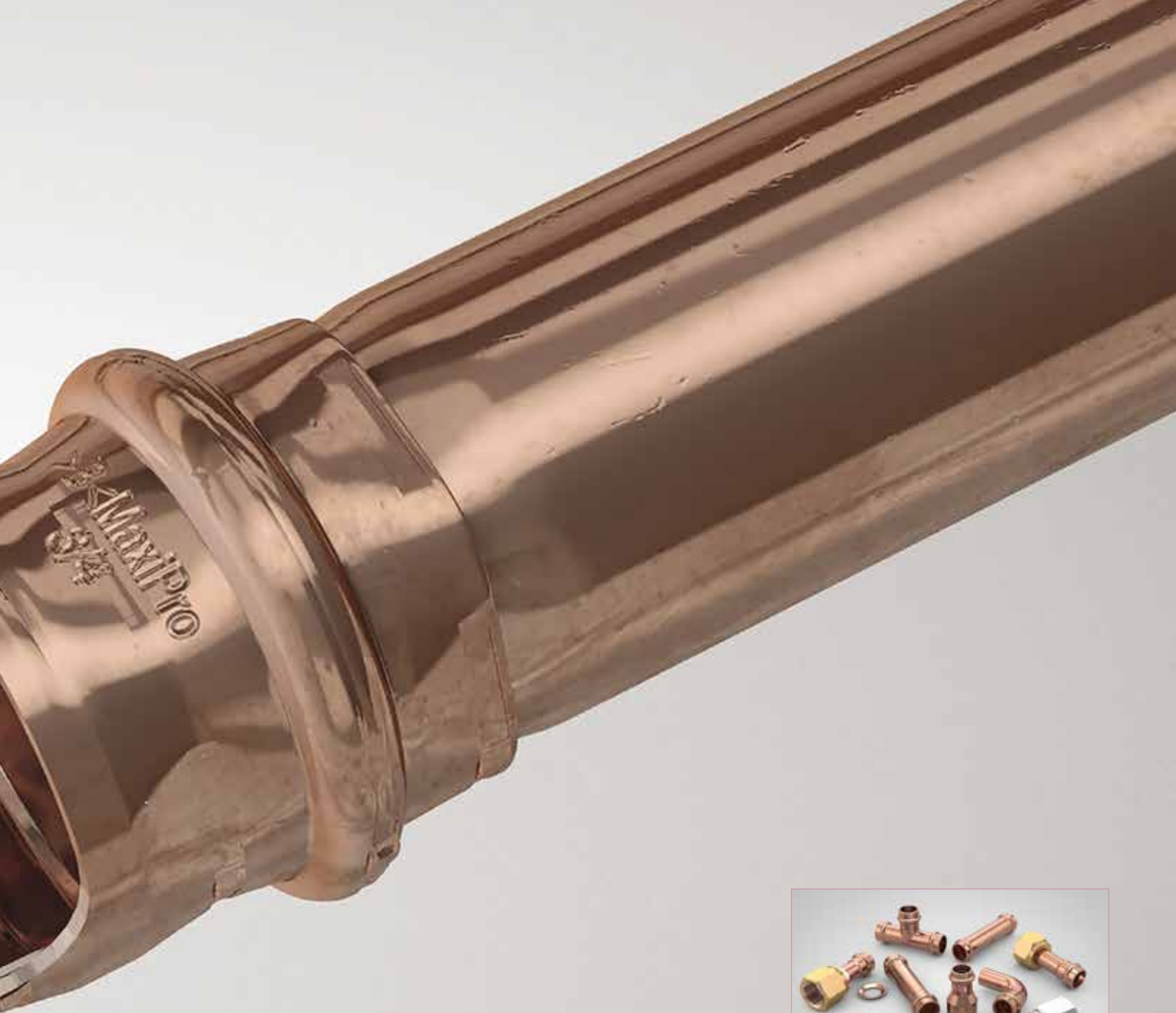

>B< **MaxiPro** is a press fitting system for use with hard, half hard or annealed copper tube conforming to EN 12735-1, EN 12735-2 or ASTM-B280. >B< MaxiPro provides a secure, permanent leak-proof joint suitable for air conditioning and refrigeration applications.

Contents

1	Applications	1
2	Features and Benefits	2
3	Technology - 3 Point Press	3
4	Technical Data	4
5	Quality Assurance	4
6	Trademarks and Patents	4
7	Size Availability	4
8	Fitting Material	4
9	Approvals, Standards and Test Compliance	4
10	Fitting Storage	5
11	Marking and Cleanliness	5
12	Design Considerations	5
	12.1 Pipework support	
	12.2 Pipework protection	
	12.3 Pipework identification and insulation	
	12.4 Earth continuity	
	12.5 Space required for the pressing process	
	12.6 Minimum distance between pressings and insertion depth	
	12.7 Minimum distance for press fittings from an existing brazed joint	
	12.8 Minimum brazing distance to an existing pressed fitting	
	12.9 Testing and commissioning of air conditioning and refrigeration systems	
	12.10 >B< MaxiPro tube compatibility tables	
13	>B< MaxiPro Installation Process	10
14	Press Tool and Jaw Compatibility	14
	14.1 Press Tool and Jaw Compatibility 19 kN	
	14.2 Press Tool and Jaw Compatibility 32 kN	
15	>B< MaxiPro Product Range - Inch	16
16	>B< MaxiPro Product Range - Metric	24
17	Extended Guarantee	30
18	Abbreviations	31
19	Frequently Asked Questions	32

Note: For further updates about >B< MaxiPro please visit www.conexbanninger.com

1. Applications

>B< MaxiPro fittings are designed for the following applications:

- Refrigeration
- Air conditioning
- Heat pump (refrigeration side)



2. Features and Benefits

Flame-free:	Flame-free installation avoids the need for a hot work permit and the risk of fire on site.
No nitrogen purge:	>B< MaxiPro is a mechanical joint, thus eliminating the need for nitrogen purge during the jointing process.
Lower installed cost:	A professional fitting which is quick and simple to install, saving time and money.
Higher productivity, improved flexibility:	Work may be completed during working hours / public access, by a single employee.
Site access:	Easy access to work sites, no gas bottles required.
Quality designed in:	Reliable, repeatable, permanent, tamper-proof connections every time.
3-point press:	Three press points, one each side of the bead, and one press compressing the O-ring. This provides a permanent and secure joint.
High quality O-ring:	A high quality HNBR O-ring forms a secure leak-free joint when pressed.
Protected O-ring:	Lead-in edge design aids tube insertion and helps protect the O-ring from damage or displacement.
Fitting identification:	Fittings are marked >B< MaxiPro and identified with a pink mark indicating their suitability for high pressure air conditioning and refrigeration applications.
Range:	Available in inch sizes 1/4" to 1 3/8" and metric sizes 6 mm to 28 mm.
Electrical continuity:	Maintains earth continuity without the need for additional earth continuity straps.
Certification:	>B< MaxiPro is UL listed, refrigerant fitting SA44668. >B< MaxiPro is UL listed, approved use for field and factory installations.
Field proven:	Press-fit technology, field proven over 20 years and millions of installed fittings worldwide.
Guarantee:	When professionally installed by a trained and certified >B< MaxiPro installer, >B< MaxiPro fittings are covered by a ten (10) year extended guarantee. Please refer to full terms and conditions, see section 17.
Support:	Backed by Conex Bänninger's experienced technical support and customer services teams.
Compact tooling:	Light compact tooling provides easy access to tightly spaced tube runs.
Tooling:	Conex Bänninger recommends the use of ROTHENBERGER press tools.

3. Technology 3-Point Press

>B< MaxiPro benefits from a 3-point press - three press points, one on each side of the bead and one press compressing the O-ring. This provides a permanent and secure joint.

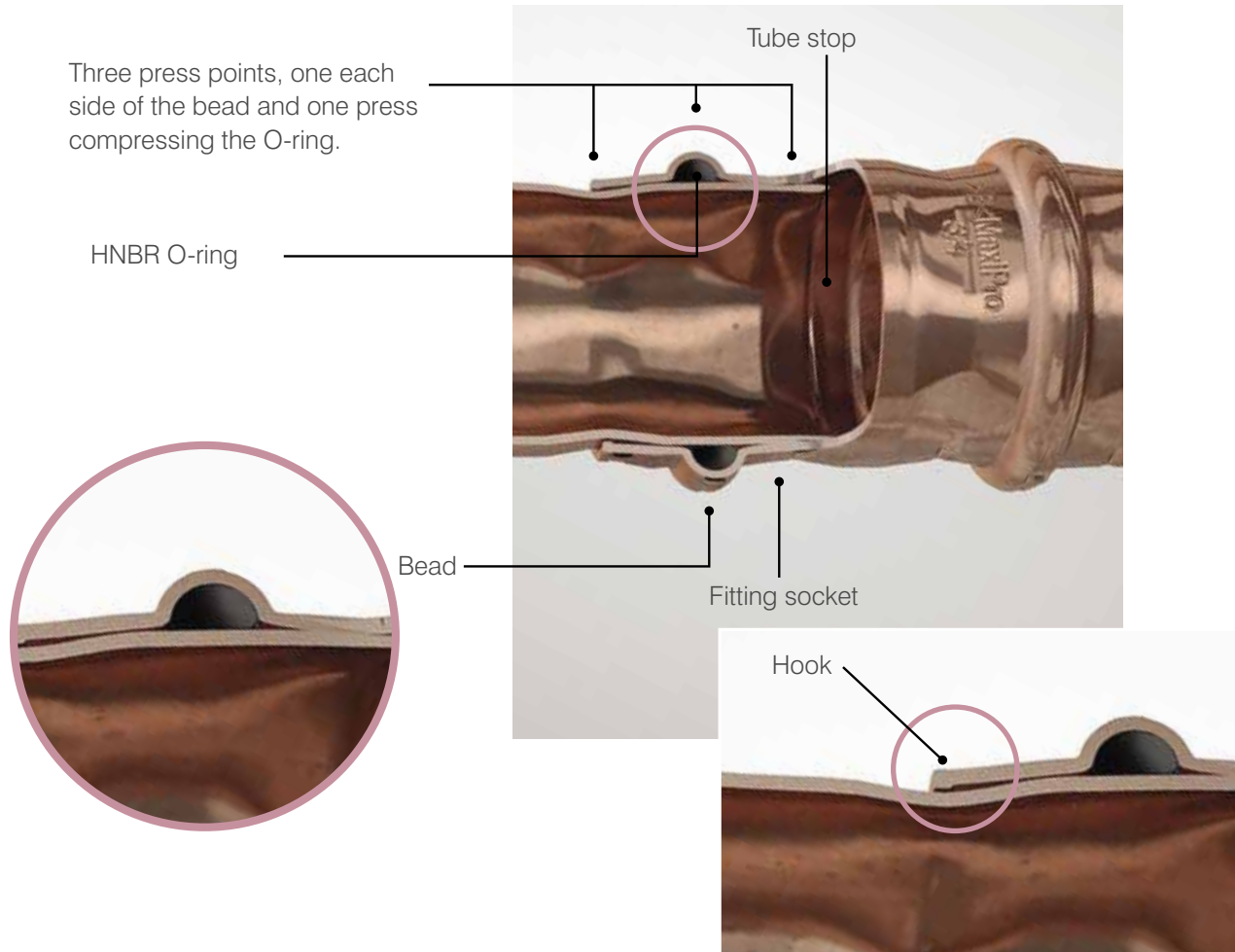

On fittings 1/2" and upwards, a hook ensures that the high pressure performance achieved by >B< MaxiPro fittings is maintained.



4. Technical Data

Table 1

Technical Data	
Parameters	Capability
Applications	Air conditioning, refrigeration, heat pump (refrigerant side)
Connections	Copper to copper
Approved tube: Copper tube conforming to*	EN 12735-1, EN 12735-2 or ASTM-B280
Fitting / tube range inch	1/4", 3/8", 1/2", 5/8", 3/4", 7/8", 1", 1 1/8", 1 3/8"
Fitting / tube range metric	6 mm, 8 mm, 10 mm, 12 mm, 15 mm, 16 mm, 18 mm, 22 mm, 28 mm
Fitting material	Refrigerant grade copper (UNS C12200 min 99.9% pure)
O-ring	HNBR
Approved oils	POE, PAO, PVE, AB and MO
Maximum operating and abnormal pressure	48 bar / 4800 kPa / 700 psig
Burst pressure >3 x maximum operating and abnormal pressure EN 378-2	>144 bar / >14400 kPa / >2100 psi
Leak tightness	Helium $\leq 7.5 \times 10^{-7}$ Pa.m ³ /s at +20 °C, 10 bar
Vacuum	200 microns
O-ring temperature range	-40 °C to 140 °C / -40 °F to 284 °F
UL listing continuous operating temperature	-40 °C to 121 °C / -40 °F to 250 °F
Compatible refrigerants	R-1234yf**, R-1234ze**, R-125, R-134a, R-290**, R-32**, R-404A, R-407A, R-407C, R-407F, R-407H, R-410A, R-417A, R-421A, R-422B, R-422D, R-427A, R-438A, R-444A**, R-447A**, R-447B**, R-448A, R-449A, R-450A, R-452A, R-452B**, R-452C, R-454A**, R-454B**, R-454C**, R-457A**, R-459A**, R-507A, R-513A, R-513B, R-515B, R-600A**, R-718 and HYCOOL 20.

*Please refer to >B< MaxiPro - Tube Compatibility Tables, see section 12.10.

** When using refrigerants classified A2L (lower flammability), A2 (flammable) and A3 (higher flammability) additional/specific standards, local rules and regulations, codes of practice and by-laws may be applicable.

Note: >B< MaxiPro fittings are NOT suitable for R-717, R-723, R-764, R-744, R-22 refrigerants.

5. Quality Assurance

Conex Bänninger is an ISO 9001 quality assured company. We are committed to providing quality products and support to our customers.

6. Trademark and Patents

>B< MaxiPro is a registered trademark in numerous territories worldwide. For information on >B< MaxiPro patents visit www.conexbanninger.com

7. Size Availability

>B< MaxiPro is available in inch and metric sizes as follows. Inch 1/4", 3/8", 1/2", 5/8", 3/4", 7/8", 1", 1 1/8" and 1 3/8". Metric 6 mm, 8 mm, 10 mm, 12 mm, 15 mm, 16 mm, 18 mm, 22 mm and 28 mm.

8. Fitting Material

>B< MaxiPro is manufactured from refrigerant grade copper (UNS C12200 min 99.9% pure).

9. Approvals, Standards and Test Compliance

- >B< MaxiPro is UL listed, refrigerant fitting SA444668.
- >B< MaxiPro is UL listed, approved use for field and factory installations.
- UL 109 - 7 Pull test, compliant.
- UL 109 - 8 Vibration test, compliant.
- UL 1963 - 79 Tests of gaskets and seals used in refrigerant systems, compliant.
- ISO 5149-2, EN 378-2 - Refrigerating systems and heat pumps - Safety and environmental requirements - Part 2: Design, construction, testing, marking and documentation, compliant.
- ISO 5149-2, EN378-2 5.3.2.2.3 Strength pressure test, compliant.
- EN 14276-2 - 8.9.4.1.2 Type burst proof test, compliant.
- ISO 14903 - 7.4 Tightness test, compliant.
- ISO 14903 - 7.6 Pressure temperature vibration test (PTV), compliant.
- ISO 14903 - 7.8 Freezing test, compliant.
- ASTM G85 salt spray (fog) test, compliant.

10. Fitting Storage

>B< MaxiPro fittings do not require special storage conditions. However to protect the HNBR O-ring a few simple precautions should be taken.

The O-rings should be protected from light sources, in particular direct sunlight or intense artificial light having a high ultra-violet content.

As ozone is particularly harmful to rubber, storage rooms should not contain any equipment that is capable of generating ozone, such as mercury vapour lamps or high-voltage electrical equipment giving rise to electric sparks or silent electrical discharges.

Combustion gases and organic vapours should be excluded from storage rooms, as they may give rise to ozone via photochemical processes. Precautions should also be taken to protect stored products from all sources of ionizing radiation.

>B< MaxiPro fittings should be kept in their sealed bags to protect them from contamination.

11. Marking and Cleanliness

Each fitting is marked >B< MaxiPro, size and 48 bar (on a pink background) and is cleaned, bagged and labelled to fully comply with the cleanliness requirements of EN 12735-1, EN 12735-2 and ASTM-B280. Keep the ziplock bag sealed to protect fittings from contamination.

12. Design Considerations

All refrigeration pipelines must be designed so that the number of joints is kept to a practical minimum. Refrigeration pipelines should be designed in compliance with the following key standards and in line with local regulations, codes of practice and by-laws governing the installation. All applicable health and safety practices must be adhered to.

- EN 378-2:2016 Refrigerating systems and heat pumps. Safety and environmental requirements. Design, construction, testing, marking and documentation.
- ISO 14903:2017 Refrigerating systems and heat pumps - Qualification of tightness of components and joints.
- EN 14276-2:2020. Pressure equipment for refrigerating systems and heat pumps. Piping. General requirements.

12.1 Pipework support

All pipework should be supported by the use of appropriate clips, brackets or supports. Please refer to:

- EN 378-2:2016 Refrigerating systems and heat pumps. Safety and environmental requirements. Design, construction, testing, marking and documentation.

Local regulations, codes of practice and by-laws governing the installation must also be adhered to. Supports should be placed near to fittings when possible and additional supports may be required when using soft copper tubes or where vibration occurs.

12.2 Pipework protection

Tubing and fittings shall be protected as far as possible against adverse environmental or other external effects. Please refer to:

- EN 378-2:2016 Refrigerating systems and heat pumps. Safety and environmental requirements. Design, construction, testing, marking and documentation.

Local regulations, codes of practice and by-laws governing the installation must also be adhered to.

12.3 Pipework identification and insulation

All pipework must be installed in accordance with:

- EN 378-2:2016 Refrigerating systems and heat pumps. Safety and environmental requirements. Design, construction, testing, marking and documentation.

Local regulations, codes of practice and by-laws governing the installation must also be adhered to.

12.4 Earth continuity

>B< MaxiPro fittings maintain earth continuity without the need for additional earth continuity straps.

12.5 Space required for the pressing process

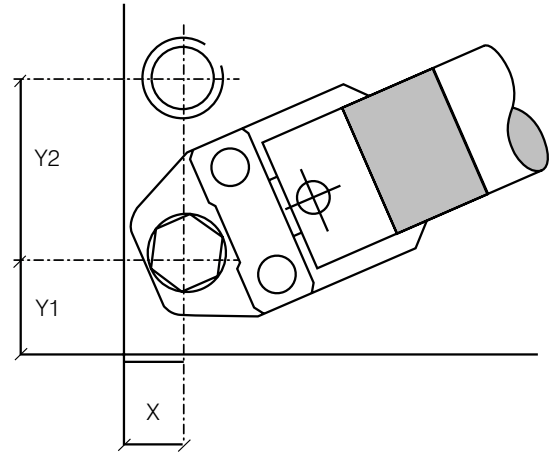
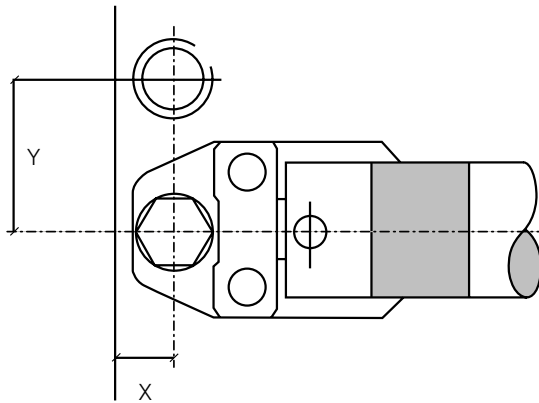

Table 2

Space required for completing a pressing between inch tubes and wall		
Inch tubes - fittings nominal OD	X	Y
Inches	mm	mm
1/4"	30	60
3/8"	30	60
1/2"	30	60
5/8"	30	60
3/4"	30	60
7/8"	35	60
1"	35	60
1 1/8"	35	60
1 3/8"	35	60

Table 4

Space required for completing a pressing between inch tubes and wall corner			
Inch tubes - fittings nominal OD	X	Y1	Y2
Inches	mm	mm	mm
1/4"	50	50	100
3/8"	50	50	105
1/2"	50	50	110
5/8"	50	50	110
3/4"	50	50	110
7/8"	60	60	120
1"	60	60	120
1 1/8"	60	60	120
1 3/8"	60	60	120

Table 3

Space required for completing a pressing between metric tubes and wall		
Metric tubes - fittings nominal OD	X	Y
mm	mm	mm
6	30	60
8	30	60
10	30	60
12	35	60
15	35	60
16	35	60
18	35	60
22	35	60
28	35	60

Table 5

Space required for completing a pressing between metric tubes and wall corner			
Metric tubes - fittings nominal OD	X	Y1	Y2
mm	mm	mm	mm
6	60	60	120
8	60	60	120
10	60	60	120
12	60	60	120
15	60	60	120
16	60	60	120
18	60	60	120
22	60	60	120
28	60	60	120

12.6 Minimum distance between pressings and insertion depth

Due to the reforming of the tube profile when pressed, it is advised that a minimum distance is allowed between each fitting.

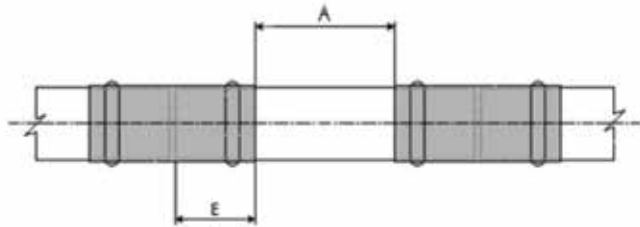

12.7 Minimum distance for press fittings from an existing brazed joint

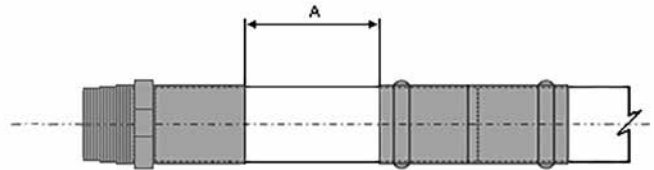

To ensure proper sealing of both the brazed and >B< MaxiPro fittings the following minimum distances must be maintained between the two fittings.

Table 6

Insertion depth and minimum distance between pressings inch tubes		
Inch tubes nominal OD	Minimum distance A	Insertion depth E
Inches	mm	mm
1/4"	10	18.0
3/8"	10	18.0
1/2"	15	19.0
5/8"	15	22.0
3/4"	20	23.0
7/8"	20	25.0
1"	25	24.0
1 1/8"	25	26.5
1 3/8"	35	35.0

Table 8

Minimum distance from a brazed joint inch tube	
Inch tubes nominal OD	Minimum distance A
Inches	mm
1/4"	10
3/8"	10
1/2"	15
5/8"	15
3/4"	20
7/8"	20
1"	25
1 1/8"	25
1 3/8"	35

Table 7

Insertion depth and minimum distance between pressings metric tubes		
Metric tubes nominal OD	Minimum distance A	Insertion depth E
mm	mm	mm
6	10	19.0
8	10	19.0
10	10	19.0
12	15	19.0
15	15	22.0
16	20	22.0
18	20	23.0
22	20	23.0
28	25	25.0

Table 9

Minimum distance from a brazed joint metric tube	
Metric tubes nominal OD	Minimum distance A
mm	mm
6	10
8	10
10	10
12	15
15	15
16	15
18	20
22	20
28	25

Note: It is important that there is no residual brazing or other foreign debris on the tubing to be inserted into the >B< MaxiPro fitting. The surface condition in the area of press joint should be clean and free from debris and comply with EN 12735-1, EN12735-2 and ASTM-B280.

12.8 Minimum brazing distance to an existing pressed fitting

Caution: Brazing near to >B< MaxiPro joints should be avoided as this may cause the seal to degrade due to heat transfer. The table below states the minimum distance away from the press joint from which it is acceptable to braze. If this distance cannot be maintained then adequate precautions must be taken such as fabricating the brazed section prior to assembly with the press fittings, wrapping in a wet rag or applying a heat barrier spray, gel or putty, to prevent heat transfer to the press fitting during brazing.

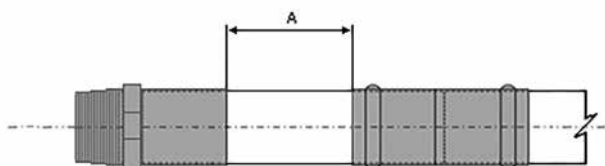

Table 10

Minimum distance brazing to an existing pressed fitting inch tubes	
Inch tubes nominal OD	Minimum distance A
Inches	mm
1/4"	250
3/8"	300
1/2"	350
5/8"	450
3/4"	500
7/8"	600
1"	650
1 1/8"	700
1 3/8"	900

Table 11

Minimum distance brazing to an existing pressed fitting metric tubes	
Metric tubes nominal OD	Minimum distance A
mm	mm
6	250
8	300
10	300
12	350
15	450
16	450
18	500
22	600
28	700

12.9 Testing and commissioning of air conditioning and refrigeration systems

Testing and commissioning of air conditioning and refrigeration systems should be in accordance with the requirements specified in:

- EN 378-2:2016 Refrigerating systems and heat pumps. Safety and environmental requirements. Design, construction, testing, marking and documentation.
 - (EU) No 517/2014 on fluorinated greenhouse gases.
- Local regulations, codes of practice and by-laws governing the installation must also be adhered to.

General

- Dry oxygen free nitrogen (OFN) should be used for tightness and strength testing as it is inert. Do not use oxygen for pressure testing, under pressure it reacts violently with hydrocarbons (oil and grease) resulting in explosions and fire.
- The maximum test pressure to be identified by the installer. This will be calculated from the system pressure and the test parameters.
- To ensure >B< MaxiPro fittings are tested safely, during the strength pressure and/or tightness test, the pressure should be raised gradually up to the desired test pressure of the system as established by the installer.
- If you are going to leave the pipework pressurized for 24 hours or longer to check for leaks, measure the system pressure and the ambient temperature at the start and finish of the tightness test. A rise in ambient temperature can mask a leak if this is not taken into account. There will be a pressure change of approximately 0.7 bar with a temperature change of 5 °C.
- Care must be taken to ensure a >B< MaxiPro joint will not be close enough to the liquid charging point that the temperature of the joint drops below -40 °C when breaking a vacuum by liquid charging the system.

Problem solving vacuum evacuation

Vacuum evacuation removes air, moisture, and non-condensable gases prior to system charging.

Failure to achieve a vacuum:

- A leak or moisture in the system (see below).
- Vacuum pump not working correctly.
- Vacuum pump does not have sufficient capacity.

Failure to hold a vacuum:

- A leak in the system or the connections to the system
 - find all leaks and repair them.
 - An ultrasonic leak detector can help pinpoint leaks on a system under vacuum.
- Moisture or refrigerant still in the system
 - continue evacuation.
- No remedial action e.g. cutting out fittings from the system should be taken until a proper fault finding exercise has been completed.

12.10 >B< MaxiPro tube compatibility tables

Table 12

>B< MaxiPro Tube Compatibility Table Inch															
>B< MaxiPro fitting size	Tube size Nominal OD		EN 12735-1 / EN 12735-2 - AS/ NZS 1571 - ASTM B280 - ASTM B88 - JIS H 3300												
			Nominal wall thickness												
	Inch	mm	0.025"	0.028" 22swg	0.030"	0.031" 0.032" 21swg	0.035" 0.036" 20swg	0.039" 0.040" 19swg	0.042"	0.045"	0.048" 18swg	0.049" 0.050"	0.055"	0.064" 0.065" 16swg	0.072" 15swg
			0.64	0.71	0.76	0.80 0.81	0.89 0.90 0.91	1.00 1.02	1.07	1.14	1.22	1.24 1.25 1.27	1.40	1.63 1.65	1.83
1/4	0.250"	6.35	■	●■	●■	●■	●■	●■							
3/8	0.375"	9.53		●■	●■	●■	●■	●■							
1/2	0.500"	12.70		●■	●■	●■	●■	●■			■	●■			
5/8	0.625"	15.88		●	●	●■	●■	●■		●	■	●■			
3/4	0.750"	19.05		●■		●■	●■	●■	●■	●■	●■	●■			
7/8	0.875"	22.23				●■	●■	●■		●■	■	■	■	●■	
1	1.000"	25.40					■	■			■			■	
1 1/8	1.125"	28.58					■	■			■	■		■	
1 3/8	1.375"	34.93										■	■		

- Coil lengths in annealed condition
- Straight lengths in hard /half hard condition

Table 13

>B< MaxiPro Tube Compatibility Table Metric				
>B< MaxiPro fitting size	Tube size Nominal OD		EN 12735-1 / EN 12735-2	
			Nominal wall thickness	
	mm	mm	1.0 mm	1.5 mm
6	6	6	●■	
8	8	8	●■	
10	10	10	●■	
12	12	12	●■	
15	15	15	●■	
16	16	16	●■	
18	18	18	●■	
22	22	22	●■	■
28	28	28	■	■

- Coil lengths in annealed condition
- Straight lengths in hard /half hard condition

Notes Tables 12 and 13:

Hardness tolerance as per approved standards in tables 12 and 13 above.

Ensure coil tubes are in round condition. Oval tubes should be re-rounded.

It is the engineer's responsibility to ensure that the tube selected is compatible with >B< MaxiPro and meets the operating pressure requirements of the system.

13. >B< MaxiPro Installation Process

General: Conex Bänninger >B<MaxiPro fittings must be installed by an installer who is appropriately trained and qualified to work on air conditioning and refrigeration installations and certified via the >B< MaxiPro training course. All installations must be completed in line with local regulations and by-laws governing the installation, and all applicable health and safety practices must be adhered to.

When using the press tools, care must be taken to ensure hands are kept away from the jaw during the pressing process. Always wear ear and eye protection.

Important: Select the correct size of tube, fitting and jaw for the job. Ensure the fitting and tube are kept free of any dust or dirt and that the O-ring is undamaged. Check the inner pressing contour of the jaw/insert is free of dirt and debris.

Do not force tube ends together prior to making joints. Joints should only be made on an unstressed pipework assembly.

Remarks:

- A joint is finished after one complete compression cycle of the tool.
- Do not press any >B< MaxiPro fitting more than once.
- Pipework alignment must be completed prior to pressing.
- Do not rotate joints after they have been pressed.

Copper tube compatibility: Please refer to tube compatibility table, section 12.10.

Maximum operating pressure: 48 bar, 4800 kPa, 700 psig.

Operating temperature range: -40 °C to 121 °C, -40 °F to 250 °F.

Compatible refrigerants: R-1234yf**, R-1234ze**, R-125, R-134a, R-290**, R-32**, R-404A, R-407A, R-407C, R-407F, R-407H, R-410A, R-417A, R-421A, R-422B, R-422D, R-427A, R-438A, R-444A**, R-447A**, R-447B**, R-448A, R-449A, R-450A, R-452A, R-452B**, R-452C, R-454A**, R-454B**, R-454C**, R-457A**, R-459A**, R-507A, R-513A, R-513B, R-515B, R-600A**, R-718 and HYCOOL 20.

** When using refrigerants classified A2L (lower flammability), A2 (flammable) and A3 (higher flammability) additional/specific standards, local rules and regulations, codes of practice and by-laws may be applicable.

>B< MaxiPro fittings are NOT suitable for R-717, R-723, R-764, R-744, R-22 refrigerants.

Compatible oils: POE, PAO, PVE, AB and MO.

Jaws:



Standard jaw



Mother jaw

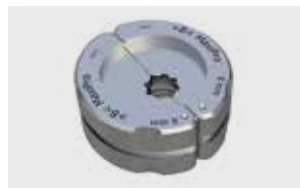

Insert

Conex Bänninger recommends the use of ROTHENBERGER press tools.

- For inch fittings compact or standard jaws can be used. 19 kN press tools can press fittings up to 1 1/8" in size, for fittings larger than this a 32 kN press tool and jaw must be used.
- For metric fittings only 19 kN press tools have been approved and can press fittings up to 28 mm. For fittings 6 mm to 28 mm a mother jaw and interchangeable inserts has been approved for use.

For full details on tool and jaw compatibility see section 14.

How to fit or change a press insert in the mother jaw:

If you are using a mother jaw with inserts to press metric fittings please follow the steps outlined below:

- Always remove the jaw from the press tool prior to changing an insert.
- Inserts come in two parts (pairs) and are keyed to slide into the jaw from the side. A spring loaded retaining pin secures the insert in place.
- The keying on the inserts and mother jaw ensures the inserts can only be inserted in the mother jaw in the correct orientation.
- Select the correct size of insert for the fitting you are about to press. Check insert halves are the same size (see step 1).
- Fit the first half of the insert from the side ensuring keying is aligned and the dot lines up with the mouth of the jaw. You will feel a click as the retaining pin secures the insert (see step 2).

- Repeat with the other half of the insert (see step 3).
- To remove the existing insert press the 2 buttons at the mouth of the jaw, one on the front and one on the back, the insert will then drop out (see step 5). To avoid risk of loss ensure the insert drops into your hand or onto a work surface.
- Store the insert you have removed in its carrying case (see step 6).

Fit inserts



1. Check sizes

- Select the correct size of insert for the fitting being pressed.
- Check insert halves are the same size.



2. Push in insert

- Push the first half of the insert into the mother jaw from the side. Ensure keying is aligned and the dot lines up with the mouth of the jaw.



3. Push in insert

- Repeat with the other half of the insert.
- Always check the insert halves are the same size before pressing any fittings.

Release inserts



4. Mother jaw with insert



5. Press buttons to release insert

- Press the 2 buttons at the mouth of the jaw, one on the front and one on the back, the insert will then drop out. To avoid risk of loss ensure the inserts drop into your hand or onto a work surface.



6. Store in case

- Store the insert you have removed in its carrying case.

Mother jaw and Conex Bänninger >B< MaxiPro inserts maintenance, service and safety:

- Mother jaws and inserts must be cleaned after every use. Keep the internal profile of the mother jaw and insert free of grease or grit.
- Mother jaws must be maintained and serviced in line with manufacturers recommendations.
- Always store the mother jaw and inserts in their case.
- Inserts are a non service item and should be checked periodically for wear and tear, with worn inserts replaced. Inserts should be replaced every 2 years.
- **For your safety, if a mother jaw or insert is damaged they must not be used, replace immediately.**

Making a joint with a >B< MaxiPro press fitting

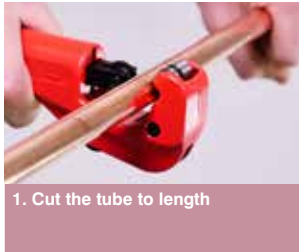

1. Cut the tube to length

- Use a rotary tube cutter.
- Ensure that the tube is cut square.
- Check the tube has retained its shape and is damage free.



2. Deburr and remove all external sharp edges

- Deburr the tube both internally and externally.
- Where possible angle the tube downwards to prevent filings entering the tube.
- Use a pencil type deburrer on internal tube edges.
- Make sure the internal and external surfaces of the tube ends are smooth and free from burrs or sharp edges.

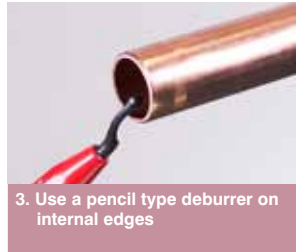

3. Use a pencil type deburrer on internal edges



4. Clean the tube end

- Thoroughly clean the tube end using ROTHENBERGER Rowlies or similar cleaning pad in a rotating action.
- Tube ends must be free from scratches, oxidation, dirt and debris.



5. Check for defects

- If deep scratches are visible, cut the tube back to a clean section and prepare the tube end again.

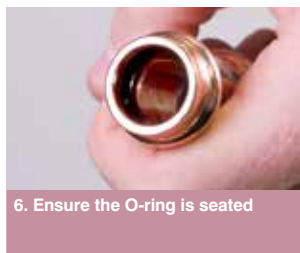

6. Ensure the O-ring is seated

- Check the fitting is the correct size for the tube.
- Check the O-rings are present and correctly seated.
- It is good practice to add a small amount of Conex Bänninger press fitting lubricant to the O-rings to aid tube insertion.



7a. Mark insertion depth on tube using depth gauge

- Insert tube into correct socket in depth gauge.
- Check window to see the tube is fully inserted.
- Mark the insertion depth on the tube.



7b. Alternatively insert tube to tube stop and mark

- The tube must be fully inserted into the fitting until it reaches the tube stop.
- To reduce the risk of dislodging the O-ring rotate the tube (if possible) while slipping it into the fitting.
- Mark the insertion depth on the tube.

12

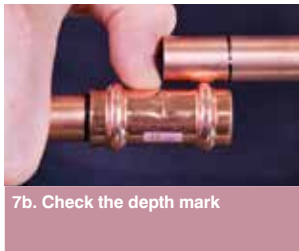

7b. Check the depth mark

- Remove the tube and align with fitting socket, check that the depth mark is correctly positioned.
- The insertion depth mark is used as a reference prior to pressing the joint.



8. Insert the tube fully into the fitting. Ensure tube is fully inserted prior to pressing

- Insert the tube fully into the fitting up to the tube stop.
- To reduce the risk of dislodging the O-ring rotate the tube (if possible) while slipping it into the fitting.
- Prior to pressing ensure the tube has not moved out from the fitting socket.
- Use the insertion depth mark as a guide.



9. Align jaws squarely on the fitting

- Ensure pipework is correctly aligned prior to pressing.
- Ensure the correct size jaw is inserted into the tool.
- The jaws must be placed squarely on the fitting locating the groove on the bead.
- The bead on the fitting should fit centrally in the groove of the jaw.



10. Complete the joint with the approved tool. Press once only

- Depress and hold the button to complete the pressing cycle.
- Pressing is complete when the jaws are fully closed and the piston retracts.
- Complete the press cycle once only – do not repress.
- Release the jaws from the pressing.



11. Mark the completed joint

- Mark the completed joint after pressing.
- This enable joints to be inspected easily before testing and insulating the pipework.



Use the QR code app on your smart phone or tablet to access www.conexbanninger.com

Installing a >B< MaxiPro female flare connector to a male flare connector.

Make the flare connection prior to pressing the >B< MaxiPro joint. If this is not possible care must be taken to prevent rotational forces being applied to the pressed joint.

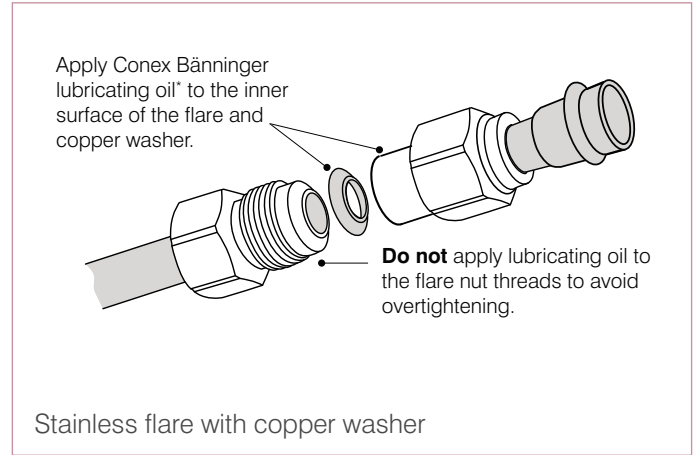
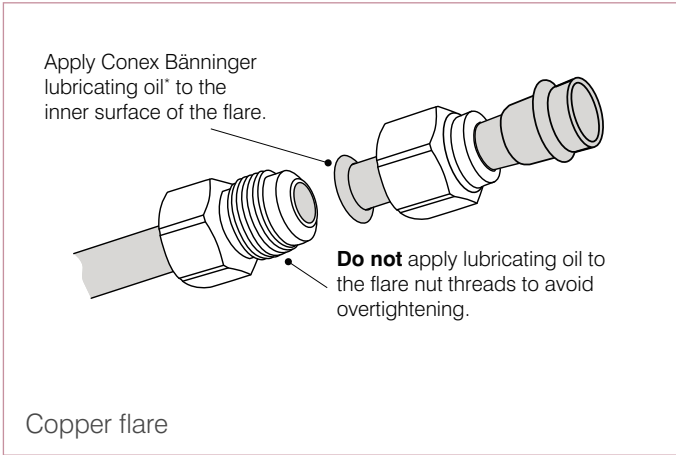

Align the centres of both flares and tighten the flares by hand.

***Note:** A compatible refrigerant oil may be used if Conex Bänninger lubricating oil is not available.

Align the centres of both flares and tighten the flares by hand.

***Note:** A compatible refrigerant oil may be used if Conex Bänninger lubricating oil is not available.

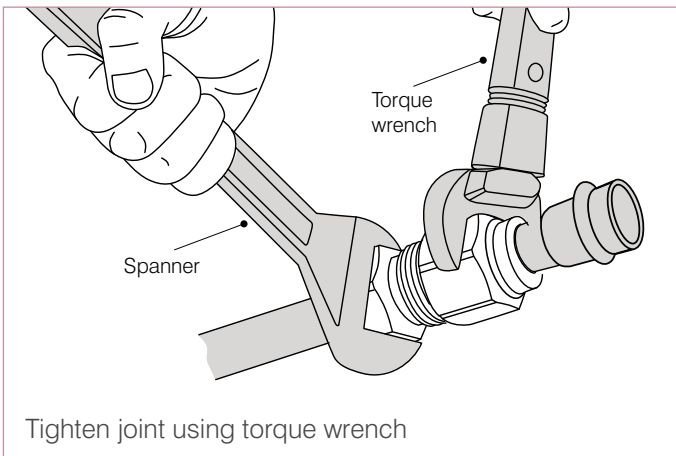

Fully tighten using spanner and torque wrench to the torque values set out in table 9. **Do not over tighten.**

Table 14

Flares Tightening Torque		
Size	Nm	ft lbf
1/4"	14-18	11-13
3/8"	33-42	25-31
1/2"	50-62	37-45
5/8"	63-77	47-56
3/4"	90-110	67-81
Do not over tighten		

14. Press Tool and Jaw Compatibility

14.1 Press Tool and Jaw Compatibility 19 kN

Conex Bänninger recommends the use of ROTHENBERGER press tools.

For inch fittings recommended and other compatible 19 kN press tools can be used with approved >B< MaxiPro jaws to press fittings up to 1 1/8". For fittings larger than 1 1/8" a 32 kN press tool must be used.

For metric fittings recommended and other compatible 19kN press tools can be used with approved mother jaw and Conex Bänninger Inserts to press fittings up to 28 mm.

All tools and jaws used must be maintained and serviced in line with manufacturers recommendations.

The tables below list the; press tools, jaws, mother jaws and inserts that may be used with >B< MaxiPro fittings. Use of non listed; press tools, jaws, mother jaws and inserts may void your guarantee.

Table 15

Approved >B< MaxiPro 19 kN jaws inch		
Size	Manufacturer	Serial No.
1/4"	ROTHENBERGER	1000001749
3/8"		1000001750
1/2"		1000001751
5/8"		1000001752
3/4"		1000001753
7/8"		1000001754
1"		1000001755
1 1/8"		1000001756

Table 16

Approved >B< MaxiPro 19 kN jaw set inch		
Size	Manufacturer	Serial No.
1/4" - 1 1/8"	ROTHENBERGER	1000001989

Table 17

Approved >B< MaxiPro 19 kN mother jaw and interchangeable inserts metric		
Size	Approved Mother Jaw	Code
6 mm	MJ03CB19KN	MPM01INS19006
8 mm		MPM01INS19008
10 mm		MPM01INS19010
12 mm		MPM01INS19012
15 mm		MPM01INS19015
16 mm		MPM01INS19016
18 mm		MPM01INS19018
22 mm		MPM01INS19022
28 mm		MPM01INS19028

Table 18

Approved >B< MaxiPro 19 kN press jaw sets metric		
Size	Contents	Code
6 mm - 28 mm	Mother jaw and Conex Bänninger 9 insert set*	MPMTOOLCASE03

* For full details of contents see section 16. >B< MaxiPro Product Range - Metric

Table 19

Recommended 19 kN press tools inch and metric		
Manufacturer	Model	Compatible
ROTHENBERGER	ROMAX® Compact TT (Europe)	✓
	ROMAX® Compact	✓
	ROMAX® TT US (USA 24 kN)	✗

Table 20

Other compatible 19 kN press tools inch		
Manufacturer	Model	Compatible
Klauke	MAP219	✓
Hilti	NPR 19-A	✓

Note: for 1 3/8" fittings the larger 32 kN tool must be used with a jaw of the appropriate size.

Table 21

Other compatible 19 kN press tools metric		
Manufacturer	Model	Compatible
Novopress	ACO102	✓
Novopress	ACO103	✓
Conel	PM1	✓

Note: For latest information on press tool and jaw compatibility information for >B< MaxiPro please visit www.conexbanninger.com

14.2 Press Tool and Jaw Compatibility 32 kN

Conex Bänninger recommends the use of ROTHENBERGER 32 kN press tools in combination with >B< MaxiPro jaws. Only ROTHENBERGER 32 kN >B< MaxiPro standard jaws are approved for use with >B< MaxiPro fittings as shown in tables 22 and 23 inch sizes.

Other 32 kN press tools with compatible press jaw interface may be used in combination with ROTHENBERGER >B< MaxiPro standard jaws. See tables 24 and 25 for recommended and other compatible press tools.

All tools and jaws used must be maintained and serviced in line with manufacturers recommendations.

Table 22

Approved >B< MaxiPro 32 kN jaws inch		
Size	Manufacturer	Serial No.
1/4"	ROTHENBERGER	1000001889
3/8"		1000001890
1/2"		1000001891
5/8"		1000001892
3/4"		1000001893
7/8"		1000001894
1"		1000001895
1 1/8"		1000001896
1 3/8"		1000002943

Table 23

Approved >B< MaxiPro 32 kN jaw sets inch		
Size	Manufacturer	Serial No.
1/4" - 1 1/8"	ROTHENBERGER 8 jaw set	1000002207
1/4" - 7/8" & 1 1/8"	ROTHENBERGER 7 jaw set (excluding 1")	1000002206

Table 24

Recommended 32 kN press tools		
Manufacturer	Model	Compatible
ROTHENBERGER	ROMAX® 3000	✓
	ROMAX® 3000 AC	✓
	ROMAX® 4000	✓
	ROMAX® AC ECO	✓

Table 25

Other compatible 32 kN press tools		
Manufacturer	Model	Compatible
Conel	PM2	✓
Dewault	DCE200	✓
Hilti	NPR 032 IE-A22	✓
Klauke	UAP2	✓
	UAP3L	✓
	UAP4L	✓
	UAP332	✓
	UNP2	✓
Milwaukee	UP2EL14	✓
	M18 Force Logic	✓
Nibco	PC-100	✓
	PC-280	✓
Novopress	ECO202	✓
	ACO202	✓
	ECO203	✓
	ACO203	✓
Rems	Akku-Press	✓
	Power-Press	✓
Ridgid	RP 320	✓
	RP 330	✓
	RP 330-B	✓
	RP 330-C	✓
	RP 340	✓
	RP 350	✓
	320-E	✓
	CT400	✓
Uponor	UP110	✓
Virax	Viper P25+	✓
	Viper P30+	✓

Note: For latest information on press tool and jaw compatibility information for >B< MaxiPro please visit www.conexbanninger.com

15. >B< MaxiPro Product Range - Inch

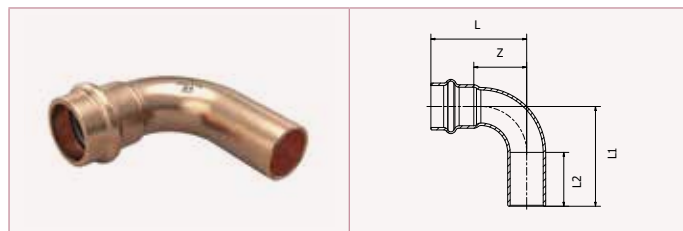

MPA5001 90° Street Bend

Code	Size	L	L1	L2	Z
MPA5001 0030001	3/8"	33.0	34.5	21.0	15.0
MPA5001 0040001	1/2"	31.5	34.5	20.5	14.0
MPA5001 0050001	5/8"	39.0	45.0	24.0	18.0
MPA5001 0060001	3/4"	42.5	48.0	25.0	20.5
MPA5001 0070001	7/8"	50.0	53.0	27.0	26.0
MPA5001 0080001	1"	54.0	56.0	26.5	31.0
MPA5001 0090001	1 1/8"	57.0	61.5	28.5	31.5
MPA5001 0110001	1 3/8"	69.0	82.0	37.0	35.0

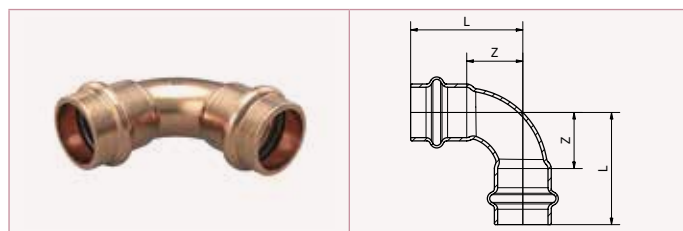

MPA5002 90° Bend

Code	Size	L	Z
MPA5002 0020001	1/4"	32.5	14.5
MPA5002 0030001	3/8"	33.0	15.0
MPA5002 0040001	1/2"	31.5	14.0
MPA5002 0050001	5/8"	39.0	18.0
MPA5002 0060001	3/4"	42.5	20.5
MPA5002 0070001	7/8"	50.0	26.0
MPA5002 0080001	1"	53.0	29.5
MPA5002 0090001	1 1/8"	57.0	31.5
MPA5002 0110001	1 3/8"	69.0	35.0

Note: All above measurements are in mm unless stated differently.

>B< MaxiPro Product Range - Inch

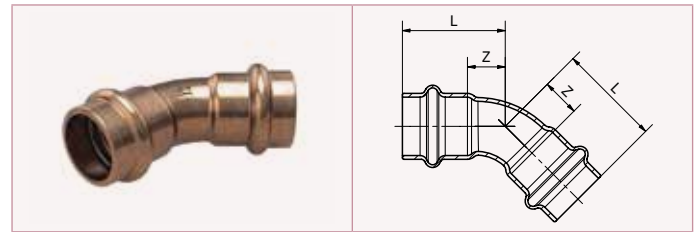

MPA5041 45° Obtuse Elbow

Code	Size	L	Z
MPA5041 0020001	1/4"	23.5	5.5
MPA5041 0030001	3/8"	26.0	8.0
MPA5041 0040001	1/2"	24.0	6.5
MPA5041 0050001	5/8"	28.0	7.0
MPA5041 0060001	3/4"	31.5	9.5
MPA5041 0070001	7/8"	34.0	10.0
MPA5041 0080001	1"	35.5	12.0
MPA5041 0090001	1 1/8"	39.5	14.0
MPA5041 0110001	1 3/8"	52.0	18.0

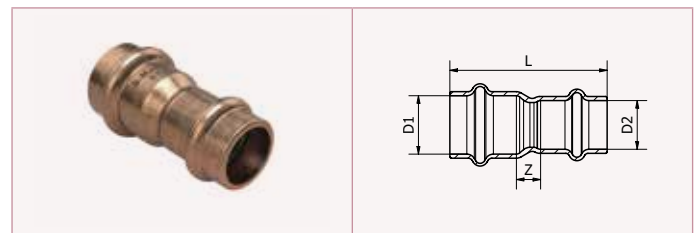

MPA5240 Reducing Coupler

Code	Size	L	Z	D1	D2
MPA5240 0030201	3/8" x 1/4"	42.0	6.0	3/8"	1/4"
MPA5240 0040201	1/2" x 1/4"	44.0	8.5	1/2"	1/4"
MPA5240 0040301	1/2" x 3/8"	42.5	7.0	1/2"	3/8"
MPA5240 0050201	5/8" x 1/4"	52.0	13.0	5/8"	1/4"
MPA5240 0050301	5/8" x 3/8"	47.5	8.5	5/8"	3/8"
MPA5240 0050401	5/8" x 1/2"	45.5	7.0	5/8"	1/2"
MPA5240 0060301	3/4" x 3/8"	51.0	11.0	3/4"	3/8"
MPA5240 0060401	3/4" x 1/2"	46.0	6.5	3/4"	1/2"
MPA5240 0060501	3/4" x 5/8"	52.5	9.5	3/4"	5/8"
MPA5240 0070401	7/8" x 1/2"	52.5	11.0	7/8"	1/2"
MPA5240 0070501	7/8" x 5/8"	52.5	7.5	7/8"	5/8"
MPA5240 0070601	7/8" x 3/4"	52.5	6.5	7/8"	3/4"
MPA5240 0080601	1" x 3/4"	55.0	9.5	1"	3/4"
MPA5240 0090501	1 1/8" x 5/8"	55.0	8.5	1 1/8"	5/8"
MPA5240 0090601	1 1/8" x 3/4"	57.5	10.0	1 1/8"	3/4"
MPA5240 0090701	1 1/8" x 7/8"	58.0	8.5	1 1/8"	7/8"
MPA5240 0090801	1 1/8" x 1"	56.0	7.0	1 1/8"	1"
MPA5240 0110701	1 3/8" x 7/8"	67.0	13.0	1 3/8"	7/8"
MPA5240 0110801	1 3/8" x 1"	72.0	15.0	1 3/8"	1"
MPA5240 0110901	1 3/8" x 1 1/8"	72.0	12.5	1 3/8"	1 1/8"

Note: All above measurements are in mm unless stated differently.

>B< MaxiPro Product Range - Inch

MPA5240L Long Reducing Coupler

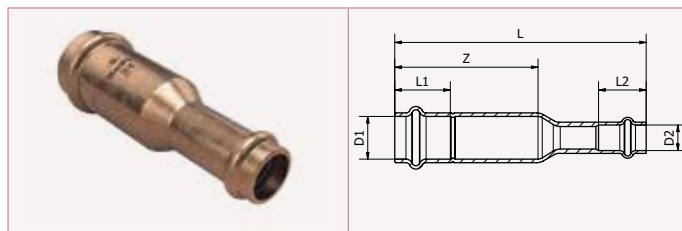

Code	Size	D1	D2	L	L1	L2	Z
MPA5240L0030201	3/8" x 1/4"	3/8"	1/4"	94.5	18.0	18.0	58.0
MPA5240L0050301	5/8" x 3/8"	5/8"	3/8"	95.0	21.0	18.0	55.5
MPA5240L0050401	5/8" x 1/2"	5/8"	1/2"	95.0	21.0	17.5	55.5
MPA5240L0080501	1" x 5/8"	1"	5/8"	100.0	23.5	21.0	53.0

MPA5243 Fitting Reducer

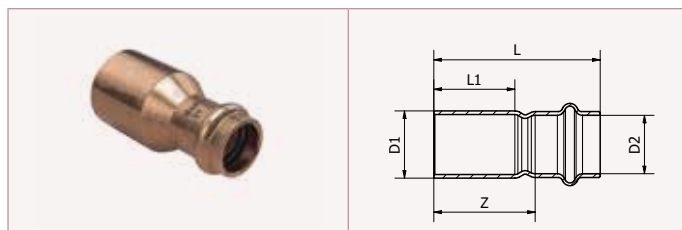

Code	Size	L	L1	Z	D1	D2
MPA5243 0030201	3/8" x 1/4"	44.0	21.0	26.0	3/8"	1/4"
MPA5243 0040301	1/2" x 3/8"	45.0	20.5	27.0	1/2"	3/8"
MPA5243 0050301	5/8" x 3/8"	47.5	24.0	29.5	5/8"	3/8"
MPA5243 0050401	5/8" x 1/2"	46.0	24.0	28.5	5/8"	1/2"
MPA5243 0060401	3/4" x 1/2"	53.0	25.0	35.5	3/4"	1/2"
MPA5243 0060501	3/4" x 5/8"	53.5	25.0	32.5	3/4"	5/8"
MPA5243 0070401	7/8" x 1/2"	54.0	27.0	36.5	7/8"	1/2"
MPA5243 0070501	7/8" x 5/8"	54.5	27.0	33.5	7/8"	5/8"
MPA5243 0070601	7/8" x 3/4"	53.0	27.0	31.0	7/8"	3/4"
MPA5243 0090401	1 1/8" x 1/2"	61.0	28.5	43.5	1 1/8"	1/2"
MPA5243 0090501	1 1/8" x 5/8"	63.5	28.5	42.5	1 1/8"	5/8"
MPA5243 0090601	1 1/8" x 3/4"	60.0	28.5	38.0	1 1/8"	3/4"
MPA5243 0090701	1 1/8" x 7/8"	59.5	28.5	35.5	1 1/8"	7/8"
MPA5243 0110701	1 3/8" x 7/8"	74.5	37.5	50.5	1 3/8"	7/8"
MPA5243 0110801	1 3/8" x 1"	72.5	37.5	49.0	1 3/8"	1"
MPA5243 0110901	1 3/8" x 1 1/8"	74.5	37.5	49.0	1 3/8"	1 1/8"

Note: All above measurements are in mm unless stated differently.

>B< MaxiPro Product Range - Inch



MPA5270 Straight Coupler

Code	Size	L	Z
MPA5270 0020001	1/4"	39.0	3.0
MPA5270 0030001	3/8"	38.0	3.0
MPA5270 0040001	1/2"	40.0	5.0
MPA5270 0050001	5/8"	45.0	3.0
MPA5270 0060001	3/4"	45.5	1.5
MPA5270 0070001	7/8"	56.5	8.5
MPA5270 0080001	1"	49.0	2.0
MPA5270 0090001	1 1/8"	57.0	6.0
MPA5270 0110001	1 3/8"	71.0	3.0

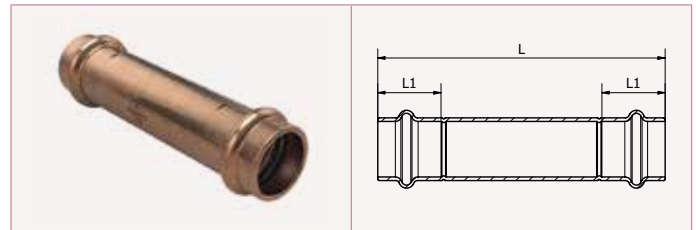

MPA5270L Long Coupler

Code	Size	L	L1
MPA5270L0020001	1/4"	90.0	18.0
MPA5270L0030001	3/8"	90.0	18.0
MPA5270L0040001	1/2"	91.0	17.5
MPA5270L0050001	5/8"	101.0	21.0
MPA5270L0060001	3/4"	101.0	22.0
MPA5270L0070001	7/8"	106.0	24.0
MPA5270L0080001	1"	105.0	23.5
MPA5270L0090001	1 1/8"	106.0	25.5

Note: All above measurements are in mm unless stated differently.

>B< MaxiPro Product Range - Inch

MPA5275L Long Repair Coupler

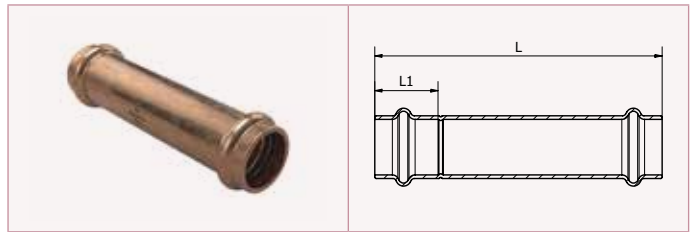

Code	Size	L	L1
MPA5275L0020001	1/4"	91.0	18.0
MPA5275L0030001	3/8"	90.0	18.0
MPA5275L0040001	1/2"	91.0	17.5
MPA5275L0050001	5/8"	101.0	21.0
MPA5275L0060001	3/4"	101.0	22.0
MPA5275L0070001	7/8"	105.0	24.0
MPA5275L0080001	1"	105.0	23.5
MPA5275L0090001	1 1/8"	106.0	25.5
MPA5275L0110001	1 3/8"	100.0	34.0

20

MPA5285G SAE Copper Flare - Brass Nut

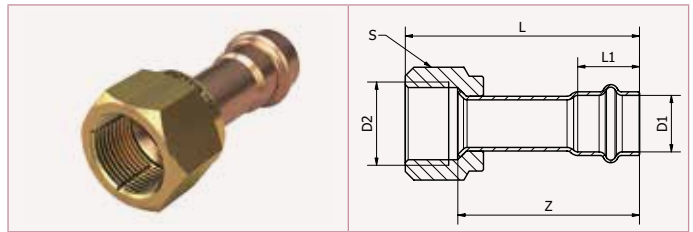

Code	Size	D1	D2	L	L1	Z	S
MPA5285G0020201	1/4"	1/4"	1/4"	54.0	18.0	46.0	17.0
MPA5285G0030301	3/8"	3/8"	3/8"	61.0	18.0	50.0	22.0
MPA5285G0040401	1/2"	1/2"	1/2"	63.5	17.5	51.5	24.0
MPA5285G0050501	5/8"	5/8"	5/8"	74.0	21.0	58.0	27.0
MPA5285G0060601	3/4"	3/4"	3/4"	81.5	22.0	63.5	34.0

MPA5286G SAE Stainless Flare - Brass Nut - Copper Washer

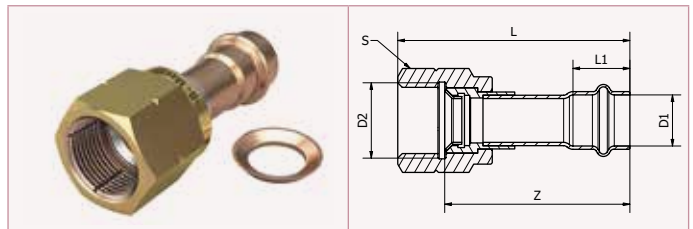

Code	Size	D1	D2	L	L1	Z	S
MPA5286G0020201	1/4"	1/4"	1/4"	64.0	18.0	55.5	17.0
MPA5286G0030301	3/8"	3/8"	3/8"	55.0	18.0	44.5	22.0
MPA5286G0040401	1/2"	1/2"	1/2"	64.5	17.5	52.5	24.0
MPA5286G0050501	5/8"	5/8"	5/8"	79.0	21.0	63.0	27.0
MPA5286G0060601	3/4"	3/4"	3/4"	85.0	22.0	67.0	34.0

Note: All above measurements are in mm unless stated differently.

>B< MaxiPro Product Range - Inch



MPA5287 Flare Copper Washer

Code	Size	L	A1
MPA5287 0020001	1/4"	3.0	45°
MPA5287 0030001	3/8"	3.5	45°
MPA5287 0040001	1/2"	4.5	45°
MPA5287 0050001	5/8"	4.5	45°
MPA5287 0060001	3/4"	6.5	45°

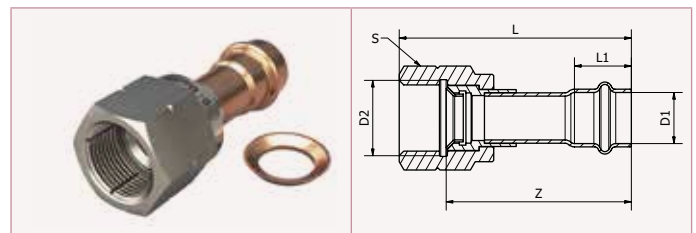

MPA5289G SAE Stainless Flare - Stainless Nut - Copper Washer

Code	Size	D1	D2	L	L1	Z	S
MPA5289G0020201	1/4"	1/4"	1/4"	64.0	18.0	55.5	17.0
MPA5289G0030301	3/8"	3/8"	3/8"	55.0	18.0	44.5	22.0
MPA5289G0040401	1/2"	1/2"	1/2"	64.5	17.5	52.5	24.0
MPA5289G0050501	5/8"	5/8"	5/8"	79.0	21.0	63.0	27.0
MPA5289G0060601	3/4"	3/4"	3/4"	85.0	22.0	67.0	34.0

21

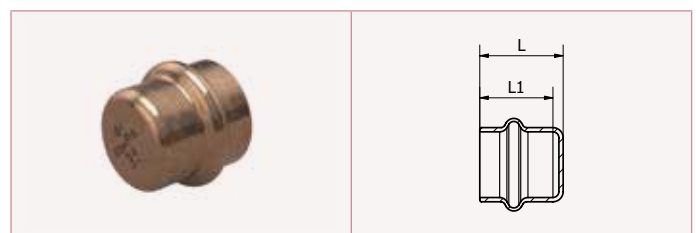

MPA5301 Stop End

Code	Size	L	L1
MPA5301 0020001	1/4"	19.5	18.0
MPA5301 0030001	3/8"	19.5	18.0
MPA5301 0040001	1/2"	19.0	17.5
MPA5301 0050001	5/8"	22.5	21.0
MPA5301 0060001	3/4"	23.5	22.0
MPA5301 0070001	7/8"	26.0	24.0
MPA5301 0080001	1"	25.5	23.5
MPA5301 0090001	1 1/8"	27.5	25.5
MPA5301 0110001	1 3/8"	37.5	34.0

Note: All above measurements are in mm unless stated differently.

>B< MaxiPro Product Range - Inch

MPA5T Equal Tee

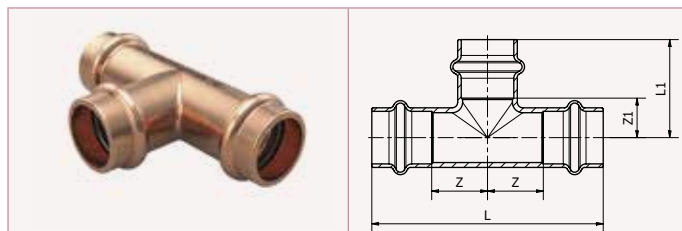

Code	Size	L	Z	L1	Z1
MPA5T 002020201	1/4"	54.0	9.0	27.0	9.0
MPA5T 003030301	3/8"	63.0	13.5	31.0	13.0
MPA5T 004040401	1/2"	66.0	15.5	28.0	10.5
MPA5T 005050501	5/8"	76.0	17.0	32.0	11.0
MPA5T 006060601	3/4"	84.0	20.0	36.0	14.0
MPA5T 007070701	7/8"	89.0	20.5	38.5	14.5
MPA5T 008080801	1"	92.0	22.5	40.0	16.5
MPA5T 009090901	1 1/8"	95.0	22.0	43.0	17.5
MPA5T 011111101	1 3/8"	112.0	22.0	56.0	22.0

22

MPA5698 P-Trap



Code	Size	D1	L	L1	B	Z
MPA5698 0050001	5/8"	5/8"	171.0	103.5	151.5	45.0
MPA5698 0060001	3/4"	3/4"	172.0	91.0	158.5	54.0
MPA5698 0070001	7/8"	7/8"	171.0	72.0	170.0	66.0
MPA5698 0090001	1.1/8"	1 1/8"	170.0	44.0	173.5	84.0

Note: Not UL approved.

>B< MaxiPro Product Range - Inch

MPA Depth Gauge Depth Gauge + Pen



Code	Description
MPA Depth Gauge	>B< MaxiPro Depth Gauge + Pen Inch 1/4" to 1 3/8"

MPABPSOIL Press Fitting Lubricant



Code	Size
MPABPSOIL100ML	100 ml

Note: All above measurements are in mm unless stated differently.

16. >B< MaxiPro Product Range - Metric

MPM5001 90° Street Bend

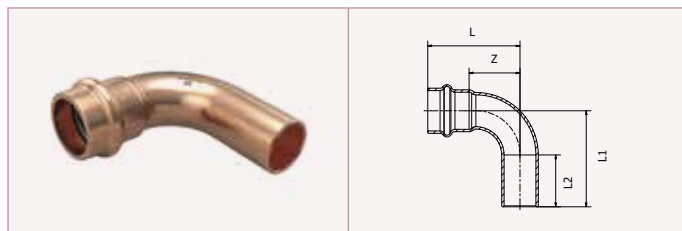

Code	Size	L	L1	L2	Z
MPM5001 0060001	6 mm	32.5	34.5	21.0	14.5
MPM5001 0080001	8 mm	33.0	36.0	21.0	15.0
MPM5001 0100001	10 mm	33.0	37.0	21.0	15.0
MPM5001 0120001	12 mm	33.0	37.0	21.0	15.0
MPM5001 0150001	15 mm	38.0	44.0	25.0	18.0
MPM5001 0160001	16 mm	39.0	45.0	24.0	18.0
MPM5001 0180001	18 mm	43.5	48.5	25.0	22.0
MPM5001 0220001	22 mm	50.0	53.0	27.0	26.0
MPM5001 0280001	28 mm	57.0	61.5	28.5	31.5

24

MPM5002 90° Bend

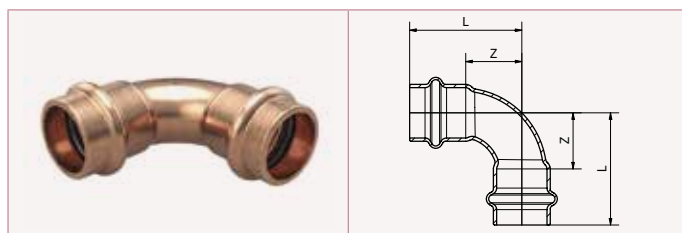

Code	Size	L	Z
MPM5002 0060001	6 mm	32.5	14.5
MPM5002 0080001	8 mm	33.0	15.0
MPM5002 0100001	10 mm	33.0	15.0
MPM5002 0120001	12 mm	33.0	15.0
MPM5002 0150001	15 mm	39.5	18.0
MPM5002 0160001	16 mm	39.0	18.0
MPM5002 0180001	18 mm	40.5	18.5
MPM5002 0220001	22 mm	50.0	26.0
MPM5002 0280001	28 mm	57.0	31.5

>B< MaxiPro Product Range - Metric

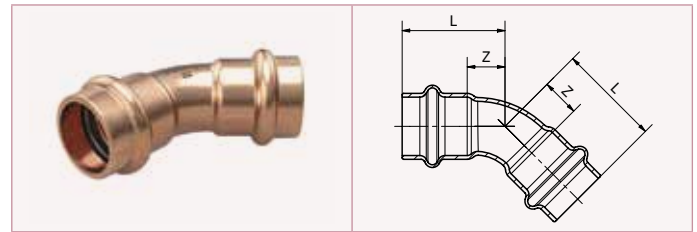

MPM5041 45° Obtuse Elbow

Code	Size	L	Z
MPM5041 0060001	6 mm	23.5	5.5
MPM5041 0080001	8 mm	24.0	6.0
MPM5041 0100001	10 mm	24.0	6.0
MPM5041 0120001	12 mm	24.0	6.0
MPM5041 0150001	15 mm	30.0	8.0
MPM5041 0160001	16 mm	28.0	7.0
MPM5041 0180001	18 mm	31.0	8.0
MPM5041 0220001	22 mm	34.0	10.0
MPM5041 0280001	28 mm	39.5	14.0

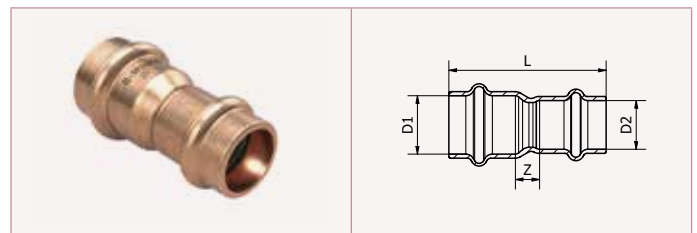

MPM5240 Reducing Coupler

Code	Size	L	Z	D1	D2
MPM5240 0080101	8 x 6 mm	42.5	5.5	8	6
MPM5240 0100601	10 x 6 mm	45.0	8.0	10	6
MPM5240 0100801	10 x 8 mm	43.0	6.0	10	8
MPM5240 0120601	12 x 6 mm	47.0	10.0	12	6
MPM5240 0120801	12 x 8 mm	45.5	8.0	12	8
MPM5240 0121001	12 x 10 mm	43.5	6.5	12	10
MPM5240 0150801	15 x 8 mm	51.0	11.0	15	8
MPM5240 0151001	15 x 10 mm	49.0	9.0	15	10
MPM5240 0151201	15 x 12 mm	46.5	6.5	15	12
MPM5240 0161001	16 x 10 mm	50.0	10.0	16	10
MPM5240 0161201	16 x 12 mm	47.5	7.5	16	12
MPM5240 0181001	18 x 10 mm	53.0	12.0	18	10
MPM5240 0181201	18 x 12 mm	50.5	9.5	18	12
MPM5240 0181501	18 x 15 mm	51.0	7.0	18	15
MPM5240 0221201	22 x 12 mm	56.0	13.0	22	12
MPM5240 0221501	22 x 15 mm	56.5	10.5	22	15
MPM5240 0221601	22 x 16 mm	55.5	9.5	22	16
MPM5240 0221801	22 x 18 mm	55.0	8.0	22	18
MPM5240 0281501	28 x 15 mm	64.0	16.5	28	15
MPM5240 0281601	28 x 16 mm	63.0	15.5	28	16
MPM5240 0281801	28 x 18 mm	62.0	13.5	28	18
MPM5240 0282201	28 x 22 mm	58.0	8.5	28	22

Note: All above measurements are in mm unless stated differently.

>B< MaxiPro Product Range - Metric

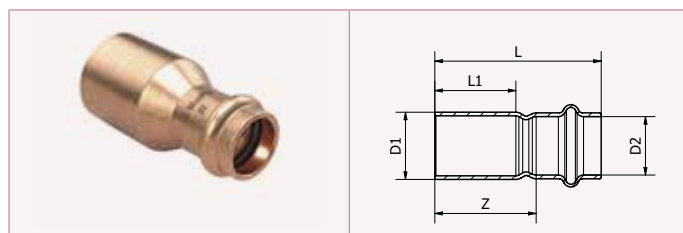

MPM5243 Fitting Reducer

Code	Size	L	L1	Z	D1	D2
MPM5243 0080601	8 x 6 mm	44.5	21.0	25.5	8	6
MPM5243 0100601	10 x 6 mm	45.5	21.0	26.5	10	6
MPM5243 0100801	10 x 8 mm	44.0	21.0	25.0	10	8
MPM5243 0120601	12 x 6 mm	47.0	21.0	28.0	12	6
MPM5243 0120801	12 x 8 mm	46.0	21.0	27.0	12	8
MPM5243 0121001	12 x 10 mm	44.5	21.0	25.5	12	10
MPM5243 0150601	15 x 6 mm	53.0	24.0	34.0	15	6
MPM5243 0150801	15 x 8 mm	51.5	24.0	32.5	15	8
MPM5243 0151001	15 x 10 mm	49.5	24.0	30.5	15	10
MPM5243 0151201	15 x 12 mm	47.0	24.0	28.0	15	12
MPM5243 0160601	16 x 6 mm	53.5	24.0	34.5	16	6
MPM5243 0160801	16 x 8 mm	52.0	24.0	33.0	16	8
MPM5243 0161001	16 x 10 mm	50.5	24.0	31.5	16	10
MPM5243 0161201	16 x 12 mm	48.0	24.0	29.0	16	12
MPM5243 0181001	18 x 10 mm	53.0	25.0	34.0	18	10
MPM5243 0181201	18 x 12 mm	51.0	25.0	31.5	18	12
MPM5243 0181501	18 x 15 mm	51.0	25.0	29.0	18	15
MPM4243 0181601	18 x 16 mm	52.0	25.0	30.0	18	16
MPM5243 0221201	22 x 12 mm	56.0	27.0	38.0	22	12
MPM5243 0221501	22 x 15 mm	56.5	27.0	34.5	22	15
MPM5243 0221601	22 x 16 mm	55.5	27.0	33.5	22	16
MPM5243 0221801	22 x 18 mm	55.0	27.0	32.0	22	18
MPM5243 0281501	28 x 15 mm	63.5	28.5	41.0	28	15
MPM5243 0281601	28 x 16 mm	59.5	28.5	40.5	28	16
MPM5243 0281801	28 x 18 mm	61.5	28.5	38.5	28	18
MPM5243 0282201	28 x 22 mm	59.0	28.5	35.0	28	22

26

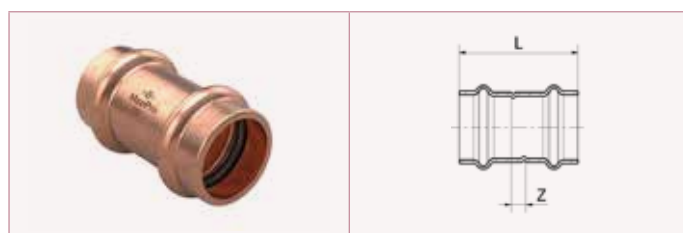

MPM5270 Straight Coupler

Code	Size	L	Z
MPM5270 0060001	6 mm	39.0	3.0
MPM5270 0080001	8 mm	39.0	3.0
MPM5270 0100001	10 mm	39.0	3.0
MPM5270 0120001	12 mm	42.0	6.0
MPM5270 0150001	15 mm	50.5	6.5
MPM5270 0160001	16 mm	45.0	3.0
MPM5270 0180001	18 mm	46.5	2.0
MPM5270 0220001	22 mm	56.5	8.5
MPM5270 0280001	28 mm	57.0	6.0

Note: All above measurements are in mm unless stated differently.

>B< MaxiPro Product Range - Metric

MPM5301 Stop End

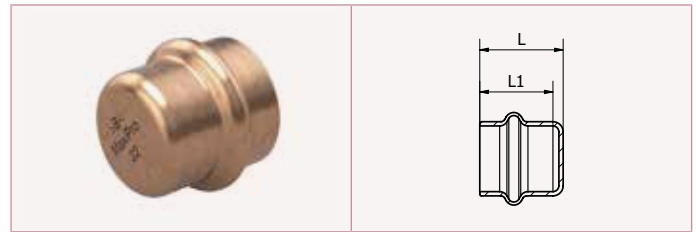

Code	Size	L	L1
MPM5301 0060001	6 mm	19.5	18.0
MPM5301 0080001	8 mm	19.5	18.0
MPM5301 0100001	10 mm	19.5	18.0
MPM5301 0120001	12 mm	20.5	18.0
MPM5301 0150001	15 mm	25.0	21.0
MPM5301 0160001	16 mm	22.5	21.0
MPM5301 0180001	18 mm	22.0	22.0
MPM5301 0220001	22 mm	26.0	24.0
MPM5301 0280001	28 mm	27.5	25.5

MPM5T Equal Tee

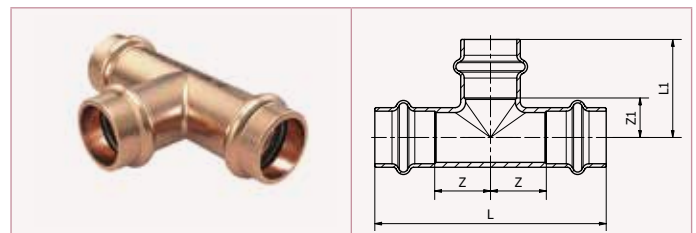

Code	Size	L	Z	L1	Z1
MPM5T 006060601	6 mm	54.0	9.0	27.0	9.0
MPM5T 008080801	8 mm	58.0	11.0	29.0	11.0
MPM5T 010101001	10 mm	61.0	12.5	30.0	12.0
MPM5T 012121201	12 mm	72.0	18.0	28.0	10.0
MPM5T 015151501	15 mm	82.0	19.0	33.0	11.0
MPM5T 016161601	16 mm	76.0	17.0	32.0	11.0
MPM5T 018181801	18 mm	83.0	17.0	37.5	13.0
MPM5T 022222201	22 mm	89.0	20.5	38.5	14.5
MPM5T 028282801	28 mm	95.0	22.0	43.5	17.5

Note: All above measurements are in mm unless stated differently.

>B< MaxiPro Product Range - Metric

MJ03CB19KN Mother Jaw



Code	Description
MJ03CB19KN	Mother Jaw 19 kN press tool

MPM01INS Insert Metric



Code	Size
MPM01INS19006	6 mm
MPM01INS19008	8 mm
MPM01INS19010	10 mm
MPM01INS19012	12 mm
MPM01INS19015	15 mm
MPM01INS19016	16 mm
MPM01INS19018	18 mm
MPM01INS19022	22 mm
MPM01INS19028	28 mm

>B< MaxiPro Product Range - Metric



MPMTOOLCASE03 Tool Case, Mother Jaw and 9 Metric Inserts*

Code	Description
MPMTOOLCASE03	>B< MaxiPro Tool Case, Mother Jaw and 9 Metric Inserts

* **Contents:** Mother jaw, 9 inserts 6-28 mm, rotary tube cutter, deburrer, pencil deburrer, depth gauge, marker pen and cleaning pads.



MPM Depth Gauge Depth Gauge + Pen

Code	Description
MPM Depth Gauge	Depth Gauge + Pen Metric 6 - 35 mm

17. Extended Guarantee

When professionally installed by a trained and certified >B< MaxiPro installer*, and used and maintained in accordance with the installation and maintenance instructions detailed in the >B< MaxiPro technical brochure, Conex Universal Ltd. guarantees that >B< MaxiPro fittings as supplied by Conex Universal Ltd. will be free of material defects resulting from errors in manufacture, for ten (10) years from the date of first purchase by an end user. This Guarantee is limited to the repair or replacement of defective product(s) (at the sole discretion of Conex Universal Ltd.). At the request of Conex Universal Ltd. the allegedly defective product(s) must be returned to the address adjacent** and Conex Universal Ltd. reserves the right to inspect and test the alleged defects. This guarantee provided by Conex Universal Ltd. does not affect your statutory rights.

The Guarantee set out above is given by Conex Universal Ltd. and subject to the following conditions:

A. Any alleged defects must be reported to Conex Universal Ltd. within one month of the first occurrence of any such alleged defect, clearly setting out the nature of the claim and the circumstances surrounding it.

B. Conex Universal Ltd. shall be under no liability in respect of any defect in any product arising from:

- defective installation,
- fair wear and tear,
- wilful damage,
- negligence of any party other than Conex Universal Ltd.,
- abnormal working or environmental conditions,
- failure to follow the instructions of Conex Universal Ltd.,
- misuse (which includes any use of the product(s) concerned for a purpose or in a situation / environment or for an application other than that for which it was designed), or
- alteration or repair of any product without the prior approval of Conex Universal Ltd.

C. At the request of Conex Universal Ltd. the person claiming under this guarantee must deliver to Conex Universal Ltd. written evidence of the date of first purchase by an end user of the product(s) concerned.

*For the installer to be suitably trained and certified for the purposes of this Product Guarantee the installer must have attended and passed a course on the >B< MaxiPro product held or expressly approved by Conex Universal Limited in relation to the use and installation of the >B< MaxiPro product.

**** The address for returns is:**

Customer Services
 Conex Universal Limited
 Global House
 95 Vantage Point
 The Pensnett Estate
 Kingswinford
 West Midlands
 DY6 7FT
 UNITED KINGDOM

18. Abbreviations

AB oil	Alkyl Benzene oil.
ASTM-B280-13	American Standard Specification for Seamless Copper Tube for Air Conditioning and Refrigeration Field Service.
CDA	Copper Development Association.
CFT	Constant Force Technology.
EN 378-2:2016	European Standard for Refrigerating systems and heat pumps. Safety and environmental requirements. Design, construction, testing, marking and documentation.
EN 12735-1:2016	European Standard for Copper and copper alloys. Seamless, round copper tubes for air conditioning and refrigeration. Tubes for piping systems.
EN 12735-2: 2016	Copper and copper alloys - Seamless, round tubes for air conditioning and refrigeration - Part 2: Tubes for equipment.
EN 14276-2:2020	European Standard for Pressure equipment for refrigerating systems and heat pumps. Piping. General requirements.
HNBR	Hydrogenated Nitrile Butadiene Rubber.
ISO 5149-2:2014	International Standard for Refrigerating systems and heat pumps - Safety and environmental requirements - Part 2: Design, construction, testing, marking and documentation.
ISO 9001	Certified quality management system.
ISO 14903:2017	International Standard for Refrigerating systems and heat pumps - Qualification of tightness of components and joints. Section 7.6 Pressure temperature vibration tests (PTV).
LED	Light Emitting Diode.
PAO oil	Poly-alpha-olefin oil.
POE oil	Polyolester oil.
PVE oil	Polyvinylether oil.
SMS	Short Message Service.
UL 207	Standard for Refrigerant-Containing Components and Accessories, Nonelectrical.
UL 1963 - 79	Standard for Refrigerant Recovery / Recycling Equipment. Section 79 Tests of Gaskets and Seals Used in Refrigerant Systems.
UL 109 - 7	Standard for Tube Fittings for Flammable and Combustible Fluids, Refrigeration Service, and Marine Use. Section 7 Pull test.
UL 109 - 8	Standard for Tube Fittings for Flammable and Combustible Fluids, Refrigeration Service, and Marine Use. Section 8 Vibration test.
UNS	Unified Numbering System.

19. Frequently Asked Questions

1. **How long is the Conex Bänninger business heritage?**
Since 1909.
2. **Where are the >B< MaxiPro fittings manufactured?**
The products are manufactured in Europe.
3. **Does >B< MaxiPro work on both hard and soft copper?**
Yes, >B< MaxiPro is a press fitting system for use with hard, half hard or annealed copper tube. Please refer to >B< MaxiPro - Tube Compatibility Tables, see section 12.10.
4. **Can you use >B< MaxiPro to crimp to aluminium, steel, or stainless steel?**
No, >B< MaxiPro is specifically designed for copper to copper connections. Connecting to dissimilar metals can cause corrosion issues that could cause a failure.
5. **What is the guarantee on >B< MaxiPro fittings?**
When professionally installed by a trained and certified >B< MaxiPro installer, >B< MaxiPro has a ten (10) year extended guarantee from the first date of purchase. Please refer to full terms and conditions, see section 18.
6. **What material is the O-ring made of?**
The O-ring is manufactured from Hydrogenated Nitrile Butadiene Rubber (HNBR).
7. **What is the expected life of the O-ring in the system?**
The O-ring is manufactured by Germany's leading producer of O-rings. The expected life of the O-ring if used within the product specifications for temperature and pressure is at least 25 years.
8. **Are there any storage issues, including where the fittings are stored in vehicles and exposed to extremes of high or low temperature?**
No, the product is not subject to degradation under normal storage conditions. Provided it is kept in original packaging and not exposed to direct sunlight for long periods. Please see section 10. for details regarding fitting storage.
9. **What refrigerants is >B< MaxiPro compatible with**
>B< MaxiPro is compatible with R-1234yf**, R-1234ze**, R-125, R-134a, R-290**, R-32**, R-404A, R-407A, R-407C, R-407F, R-407H, R-410A, R-417A, R-421A, R-422B, R-422D, R-427A, R-438A, R-444A**, R-447A**, R-447B**, R-448A, R-449A, R-450A, R-452A, R-452B**, R-452C, R-454A**, R-454B**, R-454C**, R-457A**, R-459A**, R-507A, R-513A, R-513B, R-515B, R-600A**, R-718 and HYCOOL 20.
** When using refrigerants classified A2L (lower flammability), A2 (flammable) and A3 (higher flammability) additional/ specific standards, local rules and regulations, codes of practice and by-laws may be applicable.
Note: >B< MaxiPro fittings are NOT suitable for R-717, R-723, R-764, R-744, R-22 refrigerants. Please check our website www.conexbanninger.com for updates on the >B< MaxiPro range.
10. **What oils are approved for use with >B< MaxiPro?**
>B< MaxiPro is approved for use with POE, PAO, PVE, AB and MO.
11. **If a fitting leaks on installation, can you braze the fitting rather than cutting out the joint and having to replace missing tube?**
No, if a fitting that has been pressed is leaking, the fitting must be cut out and replaced. You should not attempt to braze the fitting as you may melt the O-ring material and thus introduce contaminants into the system that could cause other system issues.
12. **Is there a concern about ice building up and then thawing under the fitting in a horizontal or vertical configuration?**
No, >B< MaxiPro has been thoroughly freeze / thaw tested. ISO 14903 - Freeze / thaw test, compliant.
13. **Are there any concerns with corrosion where installations are made in coastal areas or with respect to cleaning agents?**
No, >B< MaxiPro has been Acid Salt Spray tested to ASTM G85. As with all copper installations exposure to ammonia should be avoided.
14. **How do you know when the tool needs to be serviced?**
Please refer to manufacturers operating instructions for servicing requirements.
15. **Do >B< MaxiPro jaws need servicing?**
Please refer to manufacturers operating instructions for servicing requirements.
16. **Do Conex Bänninger >B< MaxiPro Inserts need servicing?**
Inserts are a non service item and should be checked periodically for wear and tear, with worn inserts replaced. Inserts should be replaced every 2 years.
17. **Are the >B< MaxiPro jaws compatible with any other commercially available crimping tool?**
Please see section 14. Press Tool and Jaw Compatibility. For updates on tool and jaw compatibility please visit www.conexbanninger.com.
18. **What approvals are held by >B< MaxiPro?**
>B< MaxiPro is UL listed, refrigerant fitting SA44668.
>B< MaxiPro is UL listed, approved use for field and factory installations.
UL 109 - 7 Pull test, compliant.
UL 109 - 8 Vibration test, compliant.
UL 1963 - 79 Tests of gaskets and seals used in refrigerant systems, compliant.
ISO 5149-2, EN 378-2, Refrigerating systems and heat pumps - Safety and environmental requirements – Part 2: Design, construction, testing, marking and documentation, compliant.
ISO 5149-2, EN378-2 5.3.2.2.3 Strength pressure test, compliant.
EN 14276-2 - 8.9.4.1.2 Type burst proof test, compliant.
ISO 14903 - 7.4 Tightness test, compliant.
ISO 14903 - 7.6 Pressure temperature vibration tests (PTV), compliant.

ISO 14903 - 7.8 Freezing test, compliant.
 ASTM G85 salt spray (fog) test, compliant.
 ISO 14903 - 7.6 Pressure temperature vibration tests (PTV), compliant.
 ISO 14903 - 7.8 Freezing test, compliant.
 ASTM G85 salt spray (fog) test, compliant.

19. What tube diameter is acceptable if a crimp joint is going to be made with >B< MaxiPro?

>B< MaxiPro is a press fitting system for use with hard, half hard or annealed copper tube. Please refer to >B< MaxiPro tube compatibility table, see section 12.10.

20. Does the O-ring compensate for imperfections in the tube to make a tight seal?

Yes, the O-ring does compensate for small/minor scratches on the surface of the tube. However imperfections adjacent to the crimp area such as scratches, incise marks, and tubing that is not round must be avoided.

21. The product specifications state that the application temperature limits are -40 °C to 121 °C. What happens if we go beyond that limit?

>B< MaxiPro is suitable for continuous operating at temperatures between -40 °C and +121 °C. It will also cope with short term excursions up to 140 °C. Operating at temperatures outside this range is not acceptable and may lead to failure.

22. How clean are >B< MaxiPro fittings?

>B< MaxiPro fittings comply with the cleanliness standards as required in the following Copper Tube Standards EN 12735-1, EN 12735-2 and ASTM-B280. Keep the ziplock bag sealed to protect fittings from contamination.

23. How do the fittings cope with vibration from the system?

Vibration is a recognised cause of leaks and the system must be designed and installed to comply with all local standards and codes of practice which aim to minimise vibration.

>B< MaxiPro fittings have been extensively tested to ensure the joint will not leak as a result of system vibration and complies with the following standards:

- ISO 14903 temperature pressure cycling and vibration test
- UL 109 - 8 vibration test
- UL 207 fatigue shock test

24. Will the O-ring be damaged if acid develops in the refrigeration system?

Good installation practice, a nitrogen purge during any brazing (not required with >B< MaxiPro mechanical fittings), a deep evacuation, and the proper installation and use of filter-driers containing modern and effective molecular sieve desiccants will prevent many system failures. Including the build up of acid within the system.

When selecting which desiccant material is best for an application, water capacity, refrigerant and lubricant compatibility, acid capacity, and physical strength are important characteristics and should be considered.

25. When pressed, small size fittings, particularly elbows may allow a small amount of rotational movement to be induced at the joint. Will this affect the security of the joint?

No, some rotational movement is quite acceptable, the joint will not leak nor will it come apart under pressure loading and during system operation. Some joint movement is good as it will allow for expansion and contraction in the pipework system.

26. Is >B< MaxiPro suitable for medical gas applications?

No, >B< MaxiPro is not suitable for medical gas applications.

27. Can you press a fitting more than once?

No >B< MaxiPro fittings can be pressed only once.

28. Is >B< MaxiPro approved for drinking water systems?

No >B< MaxiPro is not approved for drinking water systems.

29. Can >B< MaxiPro be used on heating and hot water systems?

No >B< MaxiPro is approved for use in air conditioning and refrigeration applications only.

30. If my system fails to achieve or hold a vacuum what should I do?

Problem Solving Vacuum Evacuation

Vacuum evacuation removes air, moisture, and non-condensable gases prior to system charging.

Failure to achieve a vacuum:

- A leak or moisture in the system (see below).
- Vacuum pump not working correctly.
- Vacuum pump does not have sufficient capacity.

Failure to hold a vacuum:

- A leak in the system or the connections to the system – find all leaks and repair them.
 - An ultrasonic leak detector can help pinpoint leaks on a system under vacuum.
- Moisture or refrigerant still in the system – continue evacuation.
- No remedial action e.g. cutting out fittings from the system should be taken until a proper fault finding exercise has been completed.

31. I am having a problem achieving a seal on a flared connection what should I do?

If you cannot achieve a seal on a flared connection, place a small drop of Conex Bänninger press fitting lubricant on the sealing face.

Conex | Bänninger

Conex | Bänninger
>B< Press

Conex | Bänninger
>B< Press Gas

Conex | Bänninger
>B< Press Solar

Conex | Bänninger
>B< Press XL

Conex | Bänninger
>B< Press Carbon

Conex | Bänninger
>B< Press Inox

Conex | Bänninger
>B< MaxiPro

Conex | Bänninger
>B< ACR

K65

Conex | Bänninger
<A> Press Inox

Conex | Bänninger
>B< Push

Conex | Bänninger
>B< Sonic

Conex | Bänninger
>B< Oyster

Conex | Bänninger
>B< Flex

Conex | Bänninger
Triflow Solder Ring

Conex | Bänninger
Delcop End Feed

Conex | Bänninger
Delbraze

Conex | Bänninger
Medical Gas

Conex | Bänninger
Valves

Conex | Bänninger
Conex Compression

Conex | Bänninger
Series 3000

Conex | Bänninger
Series 4000

Conex | Bänninger
Series 5000

Conex | Bänninger
Series 8000

Conex | Bänninger
OEM Solutions



United Kingdom
Conex Universal Limited

Germany
IBP GmbH

Spain
IBP Atcosa SL

France
Conex Bänninger SRL

Italy
IBP Bänninger Italia srl

Poland Sales, Marketing and Logistics
IBP Instal fittings Sp z.o.o.

USA
IBP Group LLC

China
IBP China

Tel: +44 (0)121 557 2831 | Fax: +44 (0)121 557 0185 | Email: salesuk@ibpgroup.com | www.conexbanninger.com

The content of this publication is for general information only. It is the user's responsibility to determine suitability of any product, product data and specifications, for the purpose intended and reference should be made to our Technical Department if clarification is required – technical@ibpgroup.com. All products must be installed in accordance with our installation instructions. In the interests of technical development we reserve the right to change specification, design and materials without notice.

Conex Bänninger products are approved by numerous Standards Authorities and Certification Bodies. This is a representation of the full range from Conex Universal Ltd. Patents and trademarks are registered in numerous countries. Details on registered and pending patents protecting our products is available at public patent registers or can be requested from legal@ibpgroup.com. All documents, images and technical data are © of Conex Universal Limited. E&OA.

More information online at: www.conexbanninger.com