



# iCHiLL 100CX

## Quick reference guide



## INDEX

1.	General Advices	2
2.	User Interface	3
3.	Remote Keyboard VICX610	4
4.	Display visualization	5
5.	Silencing the Buzzer	5
6.	First Installing	5
7.	How to Set the Clock RTC	5
8.	“ Hot Key” Programming	5
9.	Parameters Programming	6
10.	How to Change the Password	6
11.	Start / Stop Chiller or Heat Pump	6
12.	Stand- By Function	7
13.	“menu” Function	7
14.	Keyboard Functions	8
15.	Black Out	8
16.	Installing and Mounting	9
17.	Electrical Wiring	11
18.	Alarm Code and Events	12
19.	Connecting Diagram	19
20.	Parameter Table	22
21.	Technical Data	39

- Fit the probe where it is not accessible by the End User. The instrument must not be opened.
- In case of failure or faulty operation send the instrument back to the distributor or to “Dixell s.r.l.” (see address) with a detailed description of the fault.
- Consider the maximum current which can be applied to each relay (see Technical Data).
- Ensure that the wires for probes, loads and the power supply are separated and far enough from each other, without crossing or intertwining.
- In case of applications in industrial environments, the use of mains filters (our mod. FT1) in parallel with inductive loads could be useful.

### 1.2 full Manual

Dixell S.p.A. reserves the right to modify or improve this manual without prior notice.

The complete manual can be requested at the following email address.

[dixell@dixell.com](mailto:dixell@dixell.com)

## 1. GENERAL ADVICES



Please read this manual before using

- This manual is part of the product and should be kept near the instrument for easy and quick reference.
- The instrument shall not be used for purposes different from those described hereunder. It cannot be used as a safety device.
- Check the application limits before proceeding.

### 1.1 Safety Precaution

- Check the supply voltage is correct before connecting the instrument.
- Do not expose to water or moisture: use the controller only within the operating limits avoiding sudden temperature changes with high atmospheric humidity to prevent formation of condensation
- Warning: disconnect all electrical connections before any kind of maintenance.

## 2. USER INTERFACE



### 2.1 Display

**Upper digits (red color):** configurable, see parameter CF36 (PB1, PB2, PB4, Set-point (parameter value)\*, working set-point (real set-point modified from dynamic set-point, Energy saving or function for units without water storage tank), Hysteresis, Machine status \*\*)

**Lower digits (yellow color):** configurable, see parameter CF43 (PB1, PB2, PB3, PB4, Set-point (parameter value)\*, working set-point (real set-point modified from dynamic set-point, Energy saving or function for units without water storage tank), Hysteresis, RTC, Machine status \*\*).

\*the display visualizes chiller set point when the unit is on and in chiller mode, heating set point when the unit is on and in heat pump mode, and OFF when the unit is in standby.

\*\*the display visualizes OnC when the unit is on and in chiller mode, OnH when the unit is on and in heat pump mode, and OFF when the unit is in standby.





### 2.2 Icons of the Display

Icon	Meaning
°C -°F bar-PSI	ON when the display visualizes a temperature or a pressure
	On when the display visualizes the RTC, working hours, etc.
	On flashing in case of alarm
Vset	On if the Energy Saving, dynamic set-point or function for units without water storage tank are active. OFF if a function above is enabled but not active.
menu	On during menu visualization





	On if heaters are activated (antifreeze heaters or/and boiler)
	On flashing during defrost delay time. On during defrost
Flow!	On flashing if water flow switch is activated. When the pump is OFF, the led is on flashing to indicate the correct status of the digital input
	On if at least one water pump is on
	On if evaporator fans are activated
	On if a compressor is on. On flashing during the delay time for compressor activation.
	On if open collector output is active
	On if the controller is on in Heat or Cool mode
LP HP	On in case of Low pressure alarm or High pressure alarm

### 2.3 Keys

	<ol style="list-style-type: none"> <li>1. Push to enter in the Menu</li> <li>2. Push and hold (about 3 seconds) to set the clock</li> </ol>
	<ol style="list-style-type: none"> <li>1. Push to visualize the set point.</li> <li>2. Push and release 2 times: 1<sup>st</sup> time is visualized the setpoint (the value of the parameter), 2<sup>nd</sup> time is visualized the real setpoint (when Energy saving, Dynamic setpoint or function for units without water storage tank are enabled)</li> <li>3. Push and hold to modify the setpoint</li> <li>4. Push during parameter programming:                         <ul style="list-style-type: none"> <li>- to enter in parameter modification</li> <li>- to confirm the changes of the parameter</li> </ul> </li> <li>5. Menu AirM: push to reset the alarms</li> </ol>

	<ol style="list-style-type: none"> <li>1. Push and release to visualize all the probes configured</li> <li>2. In programming mode it scrolls the parameter list</li> <li>3. In programming mode increases the value of the parameters.</li> </ol>
	<ol style="list-style-type: none"> <li>1. Push and release to visualize all the probes configured</li> <li>2. In programming mode it scrolls the parameter list</li> <li>3. In programming mode decreases the value of the parameters</li> </ol>
	<ol style="list-style-type: none"> <li>1. Push and hold to switch on/off the machine (chiller or heat pump depending from CF31 parameter)</li> </ol>
	<ol style="list-style-type: none"> <li>1. Push and hold to switch on/off the machine (chiller or heat pump depending from CF31 parameter)</li> </ol>

### 2.4 Key Combination

 + 	<p>Push and hold to enter on the parameters programming</p>
 + 	<ol style="list-style-type: none"> <li>1. Push to exit to the programming parameters</li> <li>2. Push and hold to activate manual defrost</li> </ol>

### 3. REMOTE KEYBOARD VICX610



**Upper digits (red color):** configurable by parameter CF44 (PB1, PB2, PB4, Set-point (parameter value)\*, working set-point (real set-point modified from dynamic set-point, Energy saving or function for units without water storage tank), Hysteresis, Machine status \*\*))

**Lower digits (yellow color):** configurable by parameter CF45 (PB1, PB2, PB3, PB4, Set-point (parameter value)\*, working set-point (real set-point modified from dynamic set-point, Energy saving or function for units without water storage tank), Hysteresis, RTC, Machine status \*\*)).

\*the display visualizes chiller set point when the unit is on and in chiller mode, heating set point when the unit is on and in heat pump mode, and OFF when the unit is in standby.

\*\*the display visualizes OnC when the unit is on and in chiller mode, OnH when the unit is on and in heat pump mode, and OFF when the unit is in standby.

### 3.1 Key Function

Concerning the meaning of the keys, refer to paragraph 2.3.

**Air/Air unit:** using the remote keyboard with NTC sensor on board (VICX610S model and parameter CF35 = 2), the read-out and the regulation are controlled by the NTC sensor mounted on the remote keyboard.

When there is not communication between the keyboard and the instrument the display visualizes "noL" (no link message).

#### 4. DISPLAY VISUALIZATION



**Upper digits (red color):** configurable by parameter CF36 (PB1, PB2, PB4, Set-point (parameter value)\*, working set-point (real set-point modified from dynamic set-point, Energy saving or function for units without water storage tank), Hysteresis, Machine status \*\*)

**Lower digits (yellow color):** configurable by parameter CF43 (PB1, PB2, PB3, PB4, Set-point (parameter value)\*, working set-point (real set-point modified from dynamic set-point, Energy saving or function for units without water storage tank), Hysteresis, RTC, Machine status \*\*).

\*the display visualizes chiller set point when the unit is on and in chiller mode, heating set point when the unit is on and in heat pump mode, and OFF when the unit is in standby.

\*\*the display visualizes OnC when the unit is on and in chiller mode, OnH when the unit is on and in heat pump mode, and OFF when the unit is in standby.

##### 4.1 Alarm visualization



When the instrument detects an alarm, the lower display shows the alarm code alternated to probe value. The alarm icon (▲) is on flashing.

In case of HIGH PRESSURE alarm (HP), LOW PRESSURE alarm (LP) or WATER FLOW SWITCH (Flow!), dedicated icons are on.

#### 5. SILENCING THE BUZZER

**Automatically:** just after the alarm condition is recovered.

**Manually:** push and release one of the keys; the buzzer is stopped even if the alarm is still active.

#### 6. FIRST INSTALLING

After giving power supply to the instrument, the lower display can show "rtC" alternated to the probe value: **it is necessary to set the clock time.**

If the probes are not connected, or they are faulty, the display shows the corresponding alarm code.

In any case it is possible to proceed with clock setting.

#### 7. HOW TO SET THE CLOCK RTC

1. Push "menu" key for some seconds and wait until "Hour" label appears.
2. Push "SET": the hour value starts flashing.
3. Push ▼ or ▲ to change the value. Confirm by pushing "SET"; after some seconds the controller will show "Min".
4. Repeat points 2 and 3 to set other parameters:

**Min:** minutes (0+60)

**UdAy:** day of the week (**Sun** = Sunday, **Mon** = Monday, **tuE** = Tuesday, **UEd** = Wednesday, **thU** = Thursday, **Fri** = Friday, **SAt** = Saturday).

**dAy:** day of the month(0+31)

**MnTh:** Month (1+12)

**yEAR:** Year (00+99)

#### 8. "HOT KEY" PROGRAMMING

##### 8.1 Download from the Hot Key (previously programmed) to the Instrument Memory

- The controller has to be not connected to the power supply
- Insert the Hot Key into dedicated connector
- Connect the controller to the power supply
- The download starts and lasts some seconds.

During this phase the whole regulation is locked and the "dOL" message is flashing.

"End " message will appear if the programming result is good, after 15 sec. the regulation automatically restarts

If "Err" message appears the operation has given bad result. Turn the controller off and then on again to repeat the operation or restart the normal regulation.

##### 8.2 Upload the Parameter from the Controller to the Hot Key

The instrument has to be connected to the power supply:





1. Insert the Hot Key
2. Push "menu"



3. Select "UPL" function with the arrow keys
4. Push "SET" key. The Upload starts immediately. During this phase the whole regulation is locked and the "UPL" message is flashing. "End" message will appear if the programming result is good, after 15s the regulation automatically restarts. If "Err" message appears the operation has given bad result. Repeat the points 1-4 for a new Upload.

## 9. PARAMETERS PROGRAMMING

### 9.1 "Pr1" Programming Level (User Level)



How to access the "Pr1" User Level:

- 1) Push "SET" +  key for some seconds; the upper display shows "ALL" (first family of parameters).  and  icons are flashing.
- 2) Using  and  arrows scroll the other family labels.
- 3) Push "SET" to enter and see all the parameter belonging to that family. The display shows the first parameter label and its value.

Scroll the parameter list with  and  arrows or modify the value as described in 9.4.

### 9.2 "Pr2" Programming Level (Factory Level)

"Pr2" parameters level is accessible through password:

1. Enter the "Pr1" level as described in 9.1.
2. Search parameter "Pr2"; "PAS" label appears on the upper side.
3. Push "SET": the lower display shows "Pas" and the upper display shows "0" flashing.
4. Set the password using  and  keys.
5. Push SET key to confirm the value.



### 9.3 How to Move a Parameter from "Pr2" Level to "Pr1" Level

Enter the "Pr2" level and select the parameter to move; keeping pressed "SET" key, push and immediately release the  key.

The led in lower display will light to indicate the presence of the parameter in "Pr1". Then release also SET key.

To move the parameter in "Pr2" again: keep pressed SET key and immediately release the  key. The led turns off so as the parameter is not more visible in "Pr1" but just in "Pr2".

### 9.4 Changing a Parameter Value

1. Access to programming mode Pr1 or Pr2
2. Select the parameter to modify
3. Push "SET"
4. Modify the value with  and  keys

5. Push SET key again to confirm the new value; after some seconds next parameter will be displayed
6. Exit the programming mode: push "SET" and  when a parameter label is displayed, or wait 15s (time-out) without pushing any keys.









**NOTE:** The new parameter value is also confirmed if, after changing it, no SET key is pressed for the time-out to exit.

#### **ATTENTION:**

CF parameters (Configuration parameters) can be modified only if the controller is in OFF (digital input) or STD-BY.

## 10. HOW TO CHANGE THE PASSWORD

To change the password you must know the previous value. This operation is possible only starting from Pr2 level.

- 1) Enter the Pr1 level
- 2) Select a family of parameters (ST, or CF, or SD,...) and push "SET" key
- 3) Using  and  keys select the parameter "Pr2", then push "SET" key. The lower display shows "PAS" and the upper display shows 0 flashing
- 4) Use  and  keys to input the active PASSWORD; push "SET" to confirm the value and enter to Pr2 level
- 5) Search "Pr2" parameter with  and  keys
- 6) Push "SET" key to enter the new value (flashing)
- 7) Insert the new password with  and  keys.
- 8) Push "SET" key to confirm it.
- 9) The upper display will flash for few seconds then, next parameter will be showed.
- 10) Exit the programming by pushing "SET" and  together or wait the time-out.

## 11. START / STOP CHILLER OR HEAT PUMP

Press  key for 3 seconds:

- the unit starts or stops the Chiller cycle if the parameter CF31 =0
- the unit starts or stops the Heat Pump cycle if the parameter CF31 =1

The icon  flashes for 3 seconds when the controller is waiting to turn on/off.

To move from Chiller mode to Heat Pump mode or vice versa, it is necessary to stop the current cycle and then restart the new (Chiller → STD-BY → Heat Pump).



Press  key for 3 seconds:

- the unit starts or stops the Heat Pump cycle if parameter CF31 =0
- the unit starts or stops the Chiller cycle if parameter CF31 =1

The icon  flashes for 3 seconds when the controller is waiting to turn on/off.

To move from Chiller mode to Heat Pump mode or vice versa, it is necessary to stop the current cycle and then restart the new (Chiller → STD-BY → Heat Pump) .

## 12. STAND-BY FUNCTION

When the controller is working, it is possible to switch it in std-by mode pushing  or  key.

In stand-by is possible:

- Display probes value using arrow keys.
- Display and modify the set-point.
- Enter the "menu" function

## 13. "MENU" FUNCTION

Access the "menù" to perform the following operations:

1. Display and reset the active alarms.
2. Display and reset working hours of compressors and water pumps
3. Display delay time between two defrost cycles
4. Upload the parameters map from the controller to the Hot Key (see 8.2).
5. Display/reset the alarm log.

During the Menu operations the "menu" icon is on.

### 13.1 Access to the "menu"





Push and release the "menu" key. The "menu" icon is on.

### 13.2 Exit from the "menu"





Push and release the "menu" key or wait the time out. The "menu" icon disappears.

### 13.3 How to Display the Alarm Events

Enter the "menu":

1. Use  or  keys to find "ALrM" label.
  2. Push and release the "SET" key.
  3. Use  or  keys to scroll the alarm list.
- To exit the function "menu" push and release the "menu" key or wait the time-out. The "menu" icon disappears.

### 13.4 How to Reset an Alarm Event

- 1) Enter the function "menu".
- 2) Use  or  keys to find the "ALrM" label.
- 3) Push and release the "SET" key the lower display shows the alarm code.
- 4) Lower display shows the alarm code.  
Upper display shows "rSt" label if the alarm can be reset, "NO" label if it is not possible.  
Use  or  keys to scroll the alarm list.

- 5) Push "SET" key when "rSt" is lighted to reset the alarm; after a while the read-out move to next alarm.
- 6) To exit the function menu push and release the "menu" key or wait the time-out.  
The "menu" icon disappears.

## 13.5 Compressors And Pumps Working hours



Enter the function "menu".

Use  or  keys to find on the lower display:



- **C1Hr** (Compressor n°1 working hours),
- **C2Hr** (Compressor n°2 working hours),
- **PFHr** (Evaporator Water pump or supply fan working hours),
- **PCHr** (Condenser water pump working hours).

The clock icon  is lighted.





## 13.6 Reset Working Hours

1. Enter the function "menu".
2. Use  or  keys to find on the lower display the C1Hr, C2Hr, PFHr or PCHr.
3. Push "SET" key for 3 seconds: the upper display shows "0" indicating the reset.
4. To exit the function menu push and release the "menu" key or wait the time-out.  
The "menu" icon disappears.

## 13.7 How to Display the Delay Time Between Two Defrost

1. Enter the function "menu".
2. Use  or  keys to find on the upper display the "dEF" label; the lower display shows delay time between two defrost (minutes and seconds).
3. The icon  is flashing.
4. To exit the function "menu" push and release the "menu" key or wait the time-out.  
The "menu" icon disappears.

## 13.8 How to See the Alarm Log

1. Enter the function "menu".
2. Use  or  keys to find "ALOG" label.
3. Push "SET" key: the lower display shows the alarm code, the upper display shows "n°" followed by the progressive number.
4. With  or  scroll the alarm list.
5. To exit from ALOG function push "menu" key or wait the time-out delay is expired.

Memory capacity is 50 alarm structured in a FIFO list (first in first out). Each new alarm will take the place of the oldest alarm contained in the list ( the read-out is ordered from the oldest to the newest).

### 13.9 How to Reset the Alarm Log

- 1) Enter the function "menu".
- 2) Use ▲ or ▼ keys to find "ALOG" label.
- 3) Push "SET" key.
- 4) Use ▲ or ▼ keys to find "ArSt" (Alarm reset) label on the lower display; the upper display shows "PAS".
- 5) Push "SET" key and then enter the password value using ▲ or ▼ keys; confirm the value pushing "SET" key.
- 6) The ArSt label starts flashing for 5s, to confirm the alarm logging data is reset.

## 14. KEYBOARD FUNCTIONS

### 14.1 How to See the Set Point Value

Push and release the "SET" key.

Lower display shows: "SetC" set point chiller;  
"SetH" set point heat pump.

The upper display shows the value.

Note:

SetH is available only if configured for Heat Pump.

### 14.2 How to Change the Set Point Value

- 1) Push and hold "SET" key (for about 3 seconds).
- 2) The setpoint value is flashing.
- 3) Use ▲ and ▼ to increase or decrease the new value.
- 4) Push and release "SET" key or wait the time-out to exit the programming.

### 14.3 How to See the real Set Point

When Energy Saving, Dynamic Set Point or Function For Units Without Water Storage Tank are enabled is possible to see the real set point.

When the machine is running:

- push "SET" key once: lower display shows "SetC" (setpoint chiller) or "SetH" (setpoint heat pump) and upper display shows the value.
- push "SET" key again:
  - when "Energy Saving" is enabled the lower display shows "SEtS" (Energy saving setpoint) and upper display shows the value.
  - when "Dynamic Set" is enabled, the lower display shows "SEtd" (dynamic set point) and upper display shows the value.
  - when the function for units without water storage tank is enabled the lower display shows "SEtr" (real set point) and upper display shows its value.

- when two function above are both enabled, the lower display shows "SEtr" (real set point) and upper display shows its value.

## 15. BLACK OUT

After a black-out:

1. the controller restarts from the pervious status.
2. The defrost cycle is stopped.
3. All the working time delay will be reloaded.



**16. INSTALLING AND MOUNTING****16.1 "C" Format (32\*74mm)**

The instrument shall be mounted on panel, in a 29x71 mm hole, and fixed using the special bracket supplied.

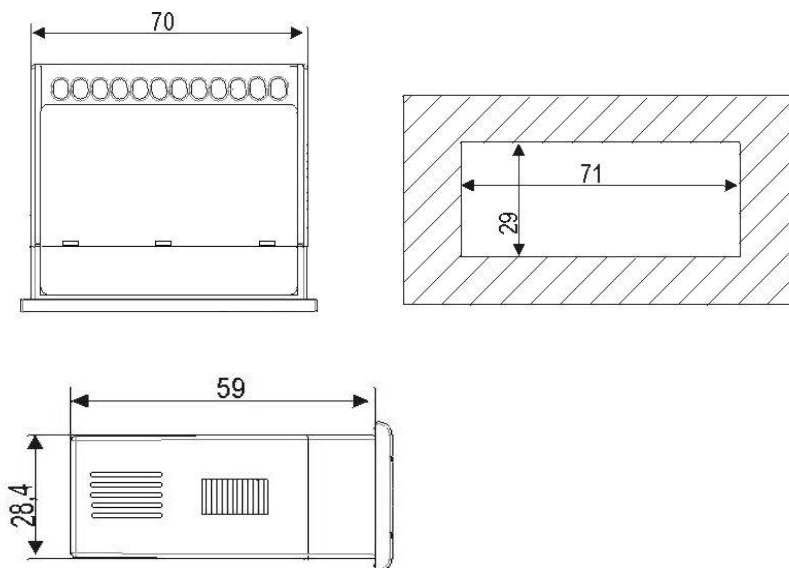

## 16.2 Remote keyboard

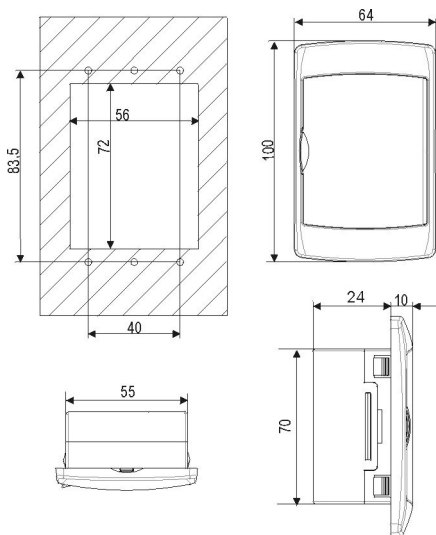

Remote terminal "Vertical" shape

Mounted on a panel with 72x56 mm cut-out, fixed with screw.

To obtain the IP65 protection, even for the panel, use the rubber gasket RGW-V (optional). For wall mounting use the V-KIT plastic adapter as illustrated in figure 2.

Fig. 2

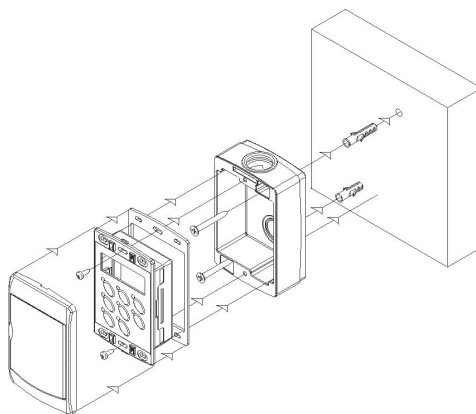

The temperature range allowed for correct operation is  $-10\text{--}60^{\circ}\text{C}$ . Avoid places subject to strong vibrations, corrosive gases, excessive dirt or humidity. The same recommendations apply to probes. Let air circulate by the cooling holes.

## 17. ELECTRICAL WIRING

The controller is provided with removable terminal blocks for wires having section not bigger than 1.0 mm<sup>2</sup>:

14 ways for supply, analogue inputs and digital inputs,

12 ways or 6 ways for relays (depending on model)

Note:

- terminals 17-19 are connected inside the controller (common for the "relay n°1" (terminal 15) and "relay n°2" (terminal 16))
- terminals 21-22 are connected inside the controller (common for the "relay n°3" (terminal 18) and "relay n°4" (terminal 20))

A 5-ways connector is dedicated to the TTL / RS485 interface.

The controller has 4 connectors (depending on model) for remote keyboard, open collector outputs, Pb4 probe, 4..20mA / 0..10Vcc analogue output; the connectors have 2 ways (0.2 mm<sup>2</sup> wires).

Remote keyboard is provided with 2-ways screw terminal block for wires not bigger than 2.5 mm<sup>2</sup>.

**Check power supply data before connection wires.**

**Keep the probe and the digital input wires separate from the power cable.**

Do not exceed the maximum rating current for each relay, check technical data and if the load is bigger, use filtered contactors.

<b>18. ALARM CODE AND EVENTS</b>				
<b>Cod</b>	<b>Meaning</b>	<b>Cause / Origin</b>	<b>Instrument behaviour</b>	<b>Reset</b>
<b>P1</b>	Pb1 probe alarm	Probe Pb1 faulty or disconnected	Open collector / alarm relay ON. Buzzer ON. General alarm icon lighted. Alarm code on display.	<b>Automatic</b> if the probe value recovers
<b>P2</b>	Pb2 probe alarm	Probe Pb2 faulty or disconnected	Open collector / alarm relay ON. Buzzer ON. General alarm icon lighted. Alarm code on display.	<b>Automatic</b> if the probe value recover
<b>P3</b>	Pb3 probe alarm	Probe Pb3 faulty or disconnected	Open collector / alarm relay ON. Buzzer ON. General alarm icon lighted. Alarm code on display.	<b>Automatic</b> if the probe value recovers
<b>P4</b>	Pb4 probe alarm	Probe Pb4 faulty or disconnected	Open collector / alarm relay ON. Buzzer ON. General alarm icon lighted. Alarm code on display.	<b>Automatic</b> if the probe value recovers
<b>A01</b>	High pressure switch alarm	Digital input for high pressure activated	Open collector / alarm relay ON. Buzzer ON. General alarm icon lighted. High pressure icon lighted. Alarm code on display.	<b>Automatic</b> It turns to manual after AL10 intervention <b>Manual:</b> after the alarm event expires, proceed with manual reset.
<b>A02</b>	Low pressure switch alarm	Digital input for low pressure activated	Open collector / alarm relay ON. Buzzer ON. General alarm icon lighted. Low pressure icon lighted. Alarm code on display.	<b>Automatic.</b> It turns to manual after AL02 events in 1 hour. <b>Manual:</b> after the alarm event expires, proceed with manual reset.

<b>A03</b>	Low temperature alarm of the supplied temperature	If CF01=0,1 and Pb1< AR03 for AR05 seconds.	Open collector / alarm relay ON. Buzzer ON. General alarm icon lighted. Alarm code on display.	<b>Automatic:</b> when Pb1 value increases over AR03+AR04 value.
<b>A04</b>	Low temperature alarm of the outlet air from evaporator.	If CF01=0,1 and Pb2< AR03 for AR05 seconds	Open collector / alarm relay ON. Buzzer ON. General alarm icon lighted. Alarm code on display.	<b>Automatic.</b> It turns to manual after Ar06 events in 1 hour. <b>Manual:</b> the event expires if Pb2 > (AR03+ AR04), then proceed with manual reset.
<b>A05</b>	High temperature High pressure	Pb3 o Pb4 > AL11	Open collector / alarm relay ON. Buzzer ON. High alarm icon lighted. Alarm code on display.	<b>Automatic.</b> It turns to manual after AL10 events in 1 hour. <b>Manual:</b> the event expires if Pb3 or Pb4 < (AL11-AL12), then proceed with manual reset.
<b>A06</b>	Low temperature Low pressure	Pb3 o Pb4 < AL14	Open collector / alarm relay ON. Buzzer ON. General alarm icon lighted. Low alarm icon lighted. Alarm code on display.	<b>Automatic.</b> It turns to manual after AL06 events in 1 hour. <b>Manual:</b> the event expires if Pb3 or Pb4 > (AL14+AL15), then proceed with manual reset.
<b>A07</b>	Anti freeze alarm	Digital input active; Anti freeze probe Pbr < AR03 in chiller mode for minimum AR05 seconds Pbr < AR27 in heat pump mode for minimum AR05 seconds	Open collector / alarm relay ON. Buzzer ON. General alarm icon lighted. Alarm code on display.	<b>Automatic.</b> It turns to manual after Ar06 events in 1 hour. <b>Manual:</b> the event expires if Pbr > (AR03+AR04) or Pbr > (AR27+AR28), or the event expires (digital input) then proceed with manual reset.
<b>A07</b>	Anti freeze alarm motocondensing unit	Digital input active CF01=6,7 and CF05=2	Open collector / alarm relay ON. Buzzer ON. General alarm icon lighted. Alarm code on display.	<b>Automatic.</b> It turns to manual Ar06 events in 1 hour. <b>Manual:</b> the event expires, then proceed with manual reset.

<p><b>A08</b></p>	<p>Evaporator water flow alarm (air/water or water/water units)</p>	<p>If CO11≠0: digital input active for AL06; the alarm signal is disabled for AL04 starting from the start-up of the evaporator pump. If CO11=0: digital input active for AL06.</p>	<ul style="list-style-type: none"> <li>• If CO11=0 Alarm relay/ open collector ON. Buzzer ON. General alarm icon lighted. Flashing "Flow!" icon. Code on display. If the unit is in std-by or OFF the icon is on to indicate the the real state of the pump and the flow switch.</li> <li>• If CO11≠0 Alarm relay/ open collector ON. Buzzer ON. General alarm icon lighted. Flashing "Flow!" icon. Code on display.</li> </ul>	<p><b>Automatic.</b> Digital input not active for AL07. It turns to manual if the digital input is active for AL05.</p> <p><b>Manual:</b> Digital input not active for AL07, then proceed with manual reset.</p>
<p><b>A09</b></p>	<p>Compressor 1 thermal protection alarm</p>	<p>Digital input active; bypassed for AL08 upon start-up of compressor</p>	<p>Open collector / alarm relay ON. Buzzer ON. General alarm icon lighted. Alarm code on display.</p>	<p><b>Manual:</b> the event expires, then proceed with manual reset.</p>
<p><b>A10</b></p>	<p>Compressor 2 thermal protection alarm</p>	<p>Digital input active</p>	<p>Open collector / alarm relay ON. Buzzer ON. General alarm icon lighted. Alarm code on display.</p>	<p><b>Manual:</b> the event expires, then proceed with manual reset.</p>
<p><b>A11</b></p>	<p>Condenser fan thermal protection alarm</p>	<p>Digital input active</p>	<p>Open collector / alarm relay ON. Buzzer ON. General alarm icon lighted. Alarm code on display</p>	<p><b>Manual:</b> the event expires, then proceed with manual reset.</p>
<p><b>A12</b></p>	<p>Defrost error alarm</p>	<p>Defrost ended for maximum time dF07 with dF02=1</p>	<p>General alarm icon lighted. Only alarm code on display.</p>	<p><b>Automatic:</b> with next proper defrost cycle. Proceed with manual reset.</p>

A13	Compressor 1 maintenance warning	Running hour > CO14	Open collector / alarm relay ON. Buzzer ON. General alarm icon lighted. Alarm code on display.	<b>Manual:</b> Proceed with the hour reset procedure 13.6
A14	Compressor 2 maintenance warning	Running hour > CO15	Open collector / alarm relay ON. Buzzer ON. General alarm icon lighted. Alarm code on display.	<b>Manual:</b> Proceed with the hour reset procedure 13.6
A15	Water pump or supply air fan (air/air) maintenance warning	Running hour > CO16	Open collector / alarm relay ON. Buzzer ON. General alarm icon lighted. Alarm code on display.	<b>Manual:</b> Proceed with the hour reset procedure 13.6
A16	High temperature evaporator inlet water	Activation from analogue input (in following priority: PB3 -> PB4 -> PB1->PB2), if probe value > AL24. The alarm is disabled for AL26 starting from ON compressor.	Alarm relay/ open collector ON. Buzzer ON. General alarm icon lighted . Code on display	<b>Automatic</b> If probe value < (AL24 – AL25). With unit OFF or in std-by. Becomes manual after AL27 intervention. <b>Manual</b> De-activation: probe value < (AL24 – AL25) and manual reset.
A17	Thermal protection alarm for evaporator water pump / supply fan	Digital input activation	Alarm relay/ open collector ON. Buzzer ON. General alarm icon lighted . Code on display	<b>Manual</b> the event expires, then proceed with manual reset
A18	Thermal protection alarm for condenser water pump	Digital input activation	<ul style="list-style-type: none"> <li>• If CO11≠0</li> </ul> Activates alarm relay/ open collector output. Activates buzzer. General alarm icon lighted . Flashing flow regulator alarm icon. Code on display	<b>Manual</b> the event expires, then proceed with manual reset

<b>A19</b>	Condenser water flow alarm	Enabled if AL32≠0. If CO26≠0: digital input active for AL30; the alarm is disabled for AL04 starting from the start-up of the condenser pump. If CO26=0: digital input active for AL30.	Alarm relay/ open collector ON. Buzzer ON. General alarm icon lighted . Flashing "Flow!" icon. Code on display. If the unit is in std-by or OFF the icon is on to indicate the the real state of the pump and the flow switch.	<b>Automatic</b> Digital input not active for AL31. It turns to manual if the digital input is active for AL29.  <b>Manual</b> Digital input not active for AL31 and proceed with manual reset.
<b>A20</b>	Condenser water pump maintenance alarm	Operating hours > CO28	Alarm relay/ open collector ON. Buzzer ON. General alarm icon lighted. Code on display.	<b>Manual</b> Reset operating hours, point 13.6
<b>rtC</b>	Clock alarm	Need to set the clock time	Open collector / alarm relay ON Buzzer ON General alarm icon lighted Alarm code on display	<b>Manual:</b> Set the clock and then proceed with manual reset.
<b>rtF</b>	Clock alarm	Faulty clock control	Open collector / alarm relay ON Buzzer ON General alarm icon lighted Alarm code on display	<b>Manual:</b> Proceed with manual reset, if nothing happens change the clock.
<b>EE</b>	EEPROM error alarm	Possible data losing	Open collector / alarm relay ON Buzzer ON General alarm icon lighted Alarm code on display	<b>Manual:</b> Proceed with manual reset., if nothing happens the controller is locked, no regulation available.
<b>ACF1</b>	Configuration alarm	Heat pump configured without reversing valve	Open collector / alarm relay ON Buzzer ON General alarm icon lighted Alarm code on display	<b>Automatic</b> After parameter proper debug.



<b>ACF2</b>	Configuration alarm	<p>Air/air or H2O/air unit and:</p> <ul style="list-style-type: none"> <li>Fa02≠0 and ventilation probe not configured</li> <li>Chiller parameters configuration differs from FA13&lt;FA14 and FA10+FA12+FA13&lt;FA11</li> <li>Heat Pump parameters configuration differs from FA22&lt;FA23 and FA20+FA21+FA22&lt;FA19</li> </ul> <p>If Ar18=2 or 3 and CF07≠3                      If Ar31=2 or 3 and CF07=3                      If CF01=3 and CF07≠6</p>	<p>Open collector / alarm relay ON                      Buzzer ON                      General alarm icon lighted                      Alarm code on display</p>	<p><b>Automatic</b>                      After parameter proper debug.</p>
<b>ACF3</b>	Configuration alarm	<p>Two digital inputs having the same function;                      two relays having the same function</p>	<p>Open collector / alarm relay ON                      Buzzer ON                      General alarm icon lighted                      Alarm code on display</p>	<p><b>Automatic</b>                      After parameter proper debug.</p>
<b>ACF4</b>	Configuration alarm	<p>CF28= 1 &amp; digital input not configured or                      CF28= 2 probe Pb4 ≠ 3</p>	<p>Open collector / alarm relay ON                      Buzzer ON                      General alarm icon lighted                      Alarm code on display</p>	<p><b>Automatic</b>                      After parameter proper debug.</p>
<b>ACF5</b>	Configuration alarm	<p>CF02 =1 &amp; (CF04 ≠2,3 &amp; CF05 ≠ 3 ) or ( CF04 = 2 and CF05 = 3 )</p>	<p>Open collector / alarm relay ON                      Buzzer ON                      General alarm icon lighted                      Alarm code on display</p>	<p><b>Automatic</b>                      After parameter proper debug.</p>
<b>FErr</b>	Functioning alarm	<p>CF04=3, CF05=3 and both digital input activated at the same time</p>	<p>Open collector / alarm relay ON                      Buzzer ON                      General alarm icon lighted                      Alarm code on display</p>	<p><b>Manual:</b>                      after the alarm event expires, proceed with manual reset.</p>
<b>AFr</b>	Frequency alarm	<p>The frequency of power supply is out of range</p>	<p>Open collector / alarm relay ON                      Buzzer ON                      General alarm icon lighted                      Alarm code on display</p>	<p><b>Automatic</b>                      When the frequency is on the range</p>

## IC100CX

<b>ALOC</b>	General alarm for machine block	Digital input activated for continuous time > AL21. Alarm enabled only if AL23=1	Alarm relay/ open collector ON. Buzzer ON Flashing flow regulator alarm icon Code on display	<b>Automatic</b> Becomes manual after AL20 intervention <b>Manual</b> De-activation: digital input not enabled for continuous time > AL22 and manual reset procedure.
<b>bLOC</b>	General alarm, signal only	Digital input activated for continuous time > AL21. Alarm enabled only if AL23=0	Alarm relay/ open collector ON. Buzzer ON. Flashing flow regulator alarm icon Code on display	<b>Automatic</b> The alarm is reset automatically and does not depend on AL20

**19. CONNECTING DIAGRAM**

**19.1 Model with 5 internal relays and 1 modulating output (0..10V or 4..20mA)**

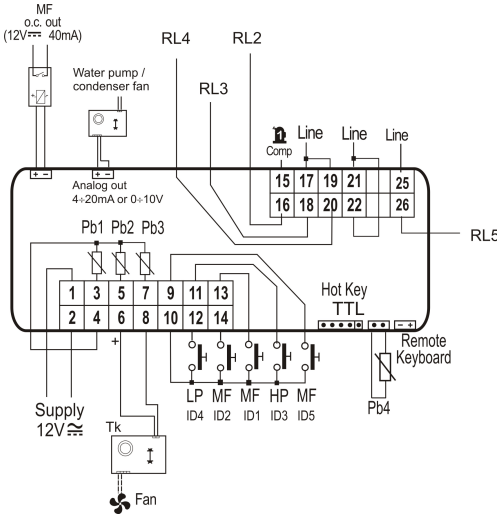

**MF ID1, MF ID2, MF ID5** = multifunction digital inputs  
**ID3** = high pressure digital input  
**ID4** = low pressure digital input  
**RL1** = compressor relay  
**MF RL2, MF RL3, MF RL4, MF RL5** = multifunction relays  
**MF o.c. out** = multifunction open collector output (for external relay)  
**Pb1, Pb2, Pb3, Pb4** = NTC probe or digital input  
**Tk** = output for external fan speed controller  
**Analog output** = output 0..10V / 4..20mA for external fan speed module (for condenser fan or modulating evaporator water pump)

**19.2 Model with triac on board and ratiometric pressure trasducer (Pb3)**

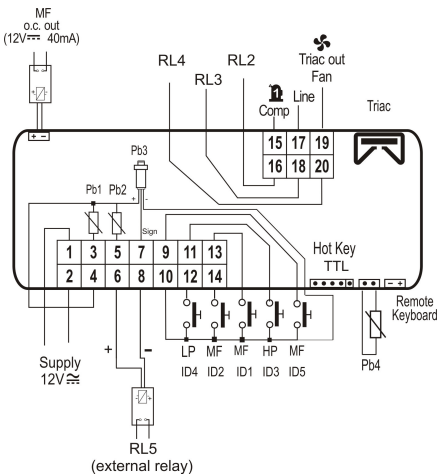

**MF ID1, MF ID2, MF ID5** = multifunction digital inputs  
**ID3** = high pressure digital input  
**ID4** = low pressure digital input  
**RL1** = compressor relay  
**MF RL2, MF RL3, MF RL4** = multifunction relays  
**RL5** = output for multifunction external relay  
**Triac out fan** = output for condenser fan  
**Pb1, Pb2, Pb4** = NTC probe or digital input  
**Pb3** = ratiometric pressure trasducer  
**MF o.c. out** = multifunction open collector output (for external relay)

**19.3 Model with 5 internal relays and pressure trasducer (Pb3)**

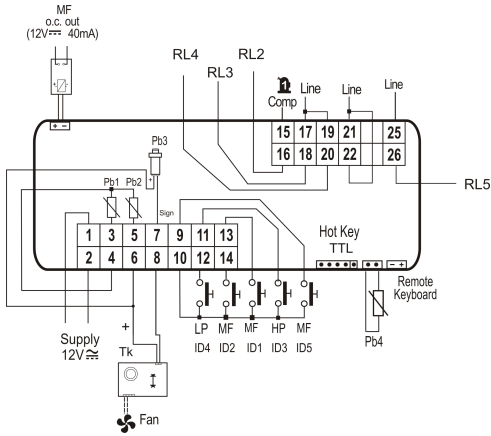

**MF ID1, MF ID2, MF ID5** = multifunction digital inputs  
**ID3** = high pressure digital input  
**ID4** = low pressure digital input  
**MF RL2, MF RL3, MF RL4, MF RL5** = multifunction relays  
**Pb1, Pb2, Pb4** = NTC probe or digital input  
**Pb3** = pressure trasducer  
**Tk** = output for external fan speed controller  
**MF o.c. out** = multifunction open collector output (for external relay)

**19.4 Model with 5 internal relays and ratiometric pressure trasducer (Pb3)**

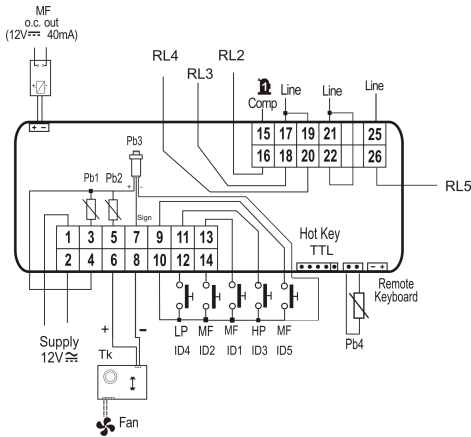

**MF ID1, MF ID2, MF ID5** = multifunction digital inputs  
**ID3** = high pressure digital input  
**ID4** = low pressure digital input  
**MF RL2, MF RL3, MF RL4, MF RL5** = multifunction relays  
**Pb1, Pb2, Pb4** = NTC probe or digital input  
**Pb3** = ratiometric pressure trasducer  
**Tk** = output for external fan speed controller  
**MF o.c. out** = multifunction open collector output (for external relay)

**19.5 Accessories**

**Serie XV:** fan speed controller (0,5KW, 1KW and 2,2KW)

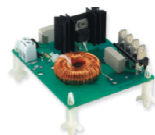

**CW15-KIT e CWC15-KIT:** Ichill wiring kit for 5 relays model and 4 relays + 1 triac model



**XJ485CX:** TTL/RS485 serial interface to connect the controller to the supervising system



**RT314 Kit:** relay module (DIN rail mounting)



**Prog TOOL KIT:** programming kit to manage parameters map from the Personal Computer



**Hot key:** parameters copying key



## 20. PARAMETER TABLE

### SUB MENU SELECTIONS

LABEL	Meaning
ALL	Shows the whole set of parameters
ST	It contains only the regulation parameters
CF	It contains only the configuration parameters
SD	It contains only the dynamic Set point parameters
ES	It contains only the Energy Saving parameters
CO	It contains only the compressor parameters
FA	It contains only the fan regulation parameters
Ar	It contains only the anti freeze parameters
DF	It contains only the defrost parameters
AL	It contains only the alarm parameters

Regulation Parameters					
Parameter	Description	Min	Max	Meas.	Resolution
ST01	Summer Set point	ST05	ST06	°C/°F	Decimal integer
ST02	Summer differential	0.0 0	25.0 45	°C °F	Decimal integer
ST03	Winter Set point	ST07	ST08	°C/°F	Decimal integer
ST04	Winter differential	0.0 0	25.0 45	°C °F	Decimal integer
ST05	Minimum set point limit for ST01 (summer)	-50.0 -58	ST01	°C °F	Decimal integer
ST06	Maximum set point limit for ST01 (summer)	ST01	110 230	°C °F	Decimal integer
ST07	Minimum set point limit for ST03 (winter)	-50.0 -58	ST03	°C °F	Decimal integer
ST08	Maximum set point limit for ST03 (winter)	ST03	110 230	°C °F	Decimal integer
ST09	Regulation band	0.0 0	25.0 45	°C °F	Decimal integer
Function for units without water storage tank					
Parameter	Description	Min	Max	Meas.	Resolution
ST10	Chiller unit without water storage tank 0= function disabled 1= function activated	0	1		
ST11	Minimum temperature Set point for outlet water in chiller mode (unit without water storage tank)	-50.0 -58	110 230	°C °F	Dec int

IC100CX

ST12	Maximum temperature Set point for outlet water in HP function (unit without water storage tank)	-50.0 -58	110 230	°C °F	Dec int
ST13	Differential set point for chiller / heat pump function	0.0 0	25.0 45	°C °F	Dec int
ST14	Offset of the differential for chiller / HP function	0.0 0	25.0 45	°C °F	Dec int
ST15	Compressor operation time above which the delta set point and delta differential for chiller / HP function is decreased	0	250	Sec	10 sec
ST16	Constant for calculating the set point value and differential for chiller/HP function	0	250		
ST17	Delay for changing the operating set point	1	250	Sec	10 sec
Geothermal chiller function					
Parameter	Description	Min	Max	Meas.	Resolution
ST18	Room set point in chiller function	ST20	ST21	°C/°F	dec/int
ST19	Room differential in chiller function	0.0 0	25.0 45	°C °F	Dec int
ST20	Minimum value of the room set point in chiller function	-50.0 -58	ST18	°C °F	Dec int
ST21	Maximum value of the room set point in chiller function	ST18	110 230	°C °F	Dec int
ST22	Room set point in heat pump function	ST24	ST25	°C/°F	dec/int
ST23	Room differential in heat pump function	0.0 0	25.0 45	°C °F	Dec int
ST24	Minimum value of the room set point in heat pump function	-50.0 -58	ST22	°C °F	Dec int
ST25	Maximum value of the room set point in heat pump function	ST22	110 230	°C °F	Dec int
Pr2	Password	0	999		

Configuration Parameters					
Parameter	Description	Min	Max	Meas.	Resolution
CF01	Unit model: 0= Chiller air / air 1= Chiller air / water 2= Chiller water / water 3= Chiller water / water with reversal on water circuit	0	3		
CF02	Motocondensing unit 0= No 1= Yes	0	1		
CF03	Regulation probe 0= Pb1 regulation 1= Pb2 regulation 2= PB2 regulation and compressors activation with user set on PB1 probe	0	2		
CF04	Pb1 configuration 0= Probe not enabled 1= NTC temperature of evaporator inlet 2= Digital input for temperature regulation demand 3= Digital input cooling demand	0	3		

IC100CX

<p><b>CF05</b></p>	<p>Pb2 configuration          0= Probe not enabled          1= NTC temperature of evaporator outlet          2= Digital Input for antifreeze alarm          3= Digital input for heating demand</p>	<p>0</p>	<p>3</p>		
<p><b>CF06</b></p>	<p>Pb3 configuration          0= Probe not enabled          1= NTC temperature condensing control          2= 4..20mA for condensing pressure          3= 4..20ma for Dynamic Set point          4= NTC temperature for anti freeze alarm (water/water)          5= NTC high temperature probe of system inlet water          6= 0..5V for condensing pressure</p>	<p>0</p>	<p>6</p>		
<p><b>CF07</b></p>	<p>Pb4 configuration          0= Probe not enabled          1= NTC condensing control          2= Multifunction digital input          3= External air temperature          4= NTC temperature for anti freeze alarm (water/water)          5= NTC temperature for combined defrost          6= NTC temperature for logging          6= NTC condenser outlet temperature (water/water units          whith reversal on water circuit)          7= NTC high temperature probe of system inlet water</p>	<p>0</p>	<p>7</p>		
<p><b>CF08</b></p>	<p>ID1 configuration          0= 1<sup>st</sup> compressor thermal protection          1= Condenser fan thermal protection          2= Evaporator flow switch alarm          3= Remote On/off          4= Remote Cooling/Heating          5= 2<sup>nd</sup> compressor thermal protection          6= 2<sup>nd</sup> compressor or step request (Motocondensing unit)          7= End defrost          8= Energy Saving          9= Anti Freeze alarm          10= 1<sup>st</sup> and 2<sup>nd</sup> compressor thermal protection          11= General alarm (unit shutdown)          12= Evaporator water pump thermal protection alarm/          supply fan thermal protection alarm          13= Condenser water pump thermal protection alarm          14= Condenser flow switch alarm          15= not used</p>	<p>0</p>	<p>15</p>		



IC100CX

<p><b>CF09</b></p>	<p>ID2 configuration            0= 1<sup>st</sup> compressor thermal protection            1= Condenser fan thermal protection            2= Evaporator flow switch alarm            3= Remote On/off            4= Cooling/Heating            5= 2<sup>nd</sup> compressor thermal protection            6= 2<sup>nd</sup> compressor or step request (Motocondensing unit)            7= End defrost            8= Energy Saving            9= Anti Freeze alarm            10= 1<sup>st</sup> and 2<sup>nd</sup> compressor thermal protection            11= General alarm for total unit shutdown            12= Evaporator water pump thermal protection alarm/            supply fan thermal protection alarm            13= Condenser water pump thermal protection alarm            14= Condenser flow switch alarm            15= not used</p>	<p>0</p>	<p>15</p>		
<p><b>CF10</b></p>	<p>ID5 configuration            0= 1<sup>st</sup> compressor thermal protection            1= Condenser fan thermal protection            2= Evaporator flow switch alarm            3= Remote On/off            4= Cooling/Heating            5= 2<sup>nd</sup> compressor thermal protection            6= 2<sup>nd</sup> compressor or step request (Motocondensing unit)            7= End defrost            8= Energy Saving            9= Anti Freeze alarm            10= 1<sup>st</sup> and 2<sup>nd</sup> compressor thermal protection            11= General alarm for total unit shutdown            12= Evaporator water pump thermal protection alarm/            supply fan thermal protection alarm            13= Condenser water pump thermal protection alarm            14= Condenser flow switch alarm            15= not used</p>	<p>0</p>	<p>15</p>		

IC100CX

<b>CF11</b>	Pb4 configuration in digital input mode 0= 1 <sup>st</sup> compressor thermal protection 1= Condenser fan thermal protection 2= Evaporator flow switch alarm 3= Remote On/off 4= Cooling/Heating 5= 2 <sup>nd</sup> compressor thermal protection 6= 2 <sup>nd</sup> compressor or step request (Motocondensing unit) 7= End defrost 8= Energy Saving 9= Anti Freeze alarm 10= 1 <sup>st</sup> and 2 <sup>nd</sup> compressor thermal protection 11= General alarm for total unit shutdown 12= Evaporator water pump thermal protection alarm/ supply fan thermal protection alarm 13= Condenser water pump thermal protection alarm 14= Condenser flow switch alarm 15= not used	0	15		
<b>CF12</b>	ID1 input polarity 0= active for closed contact 1= active for open contact	0	1		
<b>CF13</b>	ID2 input polarity 0= active for closed contact 1= active for open contact	0	1		
<b>CF14</b>	ID3 input polarity 0= active for closed contact 1= active for open contact	0	1		
<b>CF15</b>	ID4 input polarity 0= active for closed contact 1= active for open contact	0	1		
<b>CF16</b>	ID5 input polarity 0= active for closed contact 1= active for open contact	0	1		
<b>CF17</b>	Pb1 input polarity 0= active for closed contact 1= active for open contact	0	1		
<b>CF18</b>	Pb2 input polarity 0= active for closed contact 1= active for open contact	0	1		
<b>CF19</b>	Pb4 input polarity 0= active for closed contact 1= active for open contact	0	1		

**IC100CX**

<b>CF20</b>	RL4 configuration of the relay 4 0 = Alarm relay 1 = compressor 1 capacity step 2 = compressor 2 3 = ON/OFF ventilation 4 = reversing valve 5 = anti-freezer heaters / integration heater n.1 6 = solenoid valve on water circuit 7 = solenoid valve on water circuit only for heat pump 8= anti-freezer heaters / integration heater n. 2 9 = evaporator water pump / supply fan (air / air unit) 10= condenser water pump	0	10		
<b>CF21</b>	RL5 configuration of the relay 5 0 = Alarm relay 1 = compressor 1 capacity step 2 = compressor 2 3 = ON/OFF ventilation 4 = reversing valve 5 = anti-freezer heaters / integration heater n.1 6 = solenoid valve on water circuit 7 = solenoid valve on water circuit only for heat pump 8= anti-freezer heaters / integration heater n. 2 9 = evaporator water pump / supply fan (air / air unit) 10= condenser water pump	0	10		
<b>CF22</b>	4mA / 0,5V corresponding to the pressure value of the transducer	0.0 0	50.0 725	Bar Psi	Decimal integer
<b>CF23</b>	20mA / 5V corresponding to the pressure value of the transducer	0.0 0	50.0 725	Bar Psi	Decimal integer
<b>CF24</b>	Pb1 Offset	-12.0 -21.6	12.0 21.6	°C °F	Decimal integer
<b>CF25</b>	Pb2 Offset	-12.0 -21.6	12.0 21.6	°C °F	Decimal integer
<b>CF26</b>	Pb3 Offset	-12.0 -21.6 -12 -174	12.0 21.6 12 174	°C °F Bar Psi	Decimal Integer Decimal integer
<b>CF27</b>	Pb4 Offset	-12.0 -21.6	12.0 21.6	°C °F	Decimal integer
<b>CF28</b>	Chiller or Heat Pump configuration 0= chiller and heat pump selected by keyboard 1= chiller and heat pump selected by digital input 2= chiller and heat pump selected by probe 3= only chiller unit 4= only heat pump unit	0	4		
<b>CF29</b>	Automatic Changeover Setpoint	-50.0 -58	110 230	°C °F	Decimal integer
<b>CF30</b>	Differential for functioning mode	0.0 0	25.0 45	°C °F	Decimal integer
<b>CF31</b>	Chiller or Heat pump key configuration 0= ❄️ chiller / 🔥 heat pump 1= 🔥 chiller / ❄️ heat pump	0	1		

**IC100CX**

<b>CF32</b>	Celsius or Fahrenheit selection 0= °C / °BAR 1= °F / °psi	0	1		
<b>CF33</b>	Power supply frequency 0= 50 Hz 1= 60 Hz 2 = DC power supply (PWM configured as output for an external alarm relay)	0	2		
<b>CF34</b>	Serial Address for monitoring	1	247		
<b>CF35</b>	Remote terminal keyboard 0= Not used 1= 6 keys 2= 6 keys with NTC probe mounted on board	0	2		
<b>CF36</b>	Default viewing of upper display of the controller 0 = PB1 visualization 1 = PB2 visualization 2 = No visualization 3 = PB4 visualization 4 = Real working set point (set point modified from Energy Saving, Dynamic set point, function for units without water storage tank) 5 = Unit status 6 = No visualization 7 = No visualization 8 = Working differential 9 = Unit set point (parameter value)	0	8		
<b>CF37</b>	Firmware Release				
<b>CF38</b>	Eeprom – Parameter mapping				
<b>CF39</b>	RL2 configuration 0 = Alarm relay 1 = compressor 1 capacity step 2 = compressor 2 3 = ON/OFF ventilation 4 = reversing valve 5 = anti-freezer heaters / integration heater n.1 6 = solenoid valve on water circuit 7 = solenoid valve on water circuit only for heat pump 8= anti-freezer heaters / integration heater n. 2 9 = evaporator water pump / supply fan (air / air unit) 10= condenser water pump	0	10		
<b>CF40</b>	RL3 configuration 0 = Alarm relay 1 = compressor 1 capacity step 2 = compressor 2 3 = ON/OFF ventilation 4 = reversing valve 5 = anti-freezer heaters / integration heater n.1 6 = solenoid valve on water circuit 7 = solenoid valve on water circuit only for heat pump 8= anti-freezer heaters / integration heater n. 2 9 = evaporator water pump / supply fan (air / air unit) 10= condenser water pump	0	10		

IC100CX

<p><b>CF41</b></p>	<p>Open collector output configuration            0 = Alarm relay            1 = compressor 1 capacity step            2 = compressor 2            3 = ON/OFF ventilation            4 = reversing valve            5 = anti-freezer heaters / integration heater n.1            6 = solenoid valve on water circuit            7 = solenoid valve on water circuit only for heat pump            8= anti-freezer heaters / integration heater n. 2            9 = evaporator water pump / supply fan (air / air unit)            10= condenser water pump</p>	<p>0</p>	<p>10</p>		
<p><b>CF42</b></p>	<p>Switching time of reversing valve when the compressor is switched off</p>	<p>0</p>	<p>250</p>		
<p><b>CF43</b></p>	<p>Default viewing of lower display of the controller            0 = PB1 visualization            1 = PB2 visualization            2 = PB3 visualization            3 = PB4 visualization            4 = Real working set point (set point modified from Energy Saving, Dynamic set point, function for units without water storage tank)            5 = Unit status            6 = Clock            7 = No visualization            8 = Working differential            9 = Unit set point (parameter value)</p>	<p>0</p>	<p>8</p>		
<p><b>CF44</b></p>	<p>Default viewing of upper display of the remote keyboard            0 = PB1 visualization            1 = PB2 visualization            2 = no visualization (display off)            3 = PB4 visualization            4 = Real working set point (set point modified from Energy Saving, Dynamic set point, function for units without water storage tank)            5 = Unit status            6 = No visualization (display off)            7 = No visualization (display off)            8 = Working differential            9 = Unit set point (parameter value)</p>	<p>0</p>	<p>8</p>		
<p><b>CF45</b></p>	<p>Default viewing of lower display of the remote keyboard            0 = PB1 visualization            1 = PB2 visualization            2 = PB3 visualization            3 = PB4 visualization            4 = Real working set point (set point modified from Energy Saving, Dynamic set point, function for units without water storage tank)            5 = Unit status            6 = Clock            7 = No visualization            8 = Working differential            9 = Unit set point (parameter value)</p>	<p>0</p>	<p>8</p>		

CF46	Controller: visualization in Std-by mode 0 = default visualization (CF36 and CF43 parameters) 1 = the display visualizes "OFF" 2 = the display visualizes "StbY"	0	2		
CF47	Remote keyboard: visualization in Std-by mode 0 = default visualization (CF36 and CF43 parameters) 1 = the display visualizes "OFF" 2 = the display visualizes "StbY"	0	2		
CF48	Analog output configuration 0 = 4..20mA 1 = 0..10V	0	1		
Pr2	Password value	0	999		
Dynamic Setpoint					
Parameter	Description	Min	Max	Meas	Resolution
Sd01	Dynamic Setpoint 0= Not enabled 1= Enabled	0	1		
Sd02	Maximum summer dynamic Offset	- 30 -54	30 54	°C °F	Decimal integer
Sd03	Maximum winter dynamic Offset	- 30 -54	30 54	°C °F	Decimal integer
Sd04	External air d. setpoint during summer	-50.0 -58	110 230	°C °F	Decimal integer
Sd05	External air d. setpoint during winter	-50.0 -58	110 230	°C °F	Decimal integer
Sd06	External air differential during summer	- 30 -54	30 54	°C °F	Decimal integer
Sd07	External air differential during winter	- 30 -54	30 54	°C °F	Decimal integer
Pr2	Password value	0	999		
Energy Saving					
Parameter	Description	Min	Max	Meas	Resolution
ES01	Energy saving starting hour (0+24)	0	23.50	Min	10 Min
ES02	Energy saving ending hour (0+24)	0	23.50	Min	10 Min
ES03...ES09	Monday...Sunday 0 = Not enabled 1= Enabled	0	1		
ES10	Energy saving setpoint offset in chiller	-30.0 -54	30.0 54	°C °F	Decimal integer
ES11	Energy saving differential in chiller	0.1 0	25.0 45	°C °F	Decimal integer
ES12	Energy saving setpoint offset in heat pump	-30.0 -54	30.0 54	°C °F	Decimal integer
ES13	Energy saving differential in heat pump	0.1 0	25.0 45	°C °F	Decimal integer
Pr2	Password value	0	999		
Compressor parameters					
Parameter	Description	Min	Max	Meas.	Resolution
CO01	Minimum ON time	0	250	Sec	10Sec
CO02	Minimum OFF time	0	250	Sec	10Sec
CO03	ON delay time between two compressors or Comp. and valve	1	250	Sec	

CO04	OFF delay time between two compressors or Comp. and valve	0	250	Sec	
CO05	Output time delay after power supply start-up	0	250	Sec	10Sec
CO06	Compressor On delay time after Pump/"Supply fan" activation	1	250	Sec	
CO07	Compressor OFF delay time after Pump/"Supply fan" deactivation	0	250	Sec	
CO08	Compressor rotating control 0= Enabled 1= Fixed sequence	0	1		
CO09	Time delay for solenoid valve of water side (CF39)	0	250	Sec	
CO10	Stage vale polarity 0= Capacity stage ON 1= Capacity stage OFF	0	1		
CO11	Water pump / Supply fan operating mode 0= Not used 1= Always on (ON/OFF output) 2= ON if the compressor is on (ON/OFF output) 3= Always on (4÷20mA output) 4= ON if compressor is ON (4÷20mA output)	0	4		
CO12	Compressor 1 0 = Enabled 1 = OFF	0	1		
CO13	Compressor 2 / Stage valve. 0 = Enabled 1= OFF	0	1		
CO14	Hour counter setpoint for 1 <sup>st</sup> compressor	0	999	Hr	10 Hr
CO15	Hour counter setpoint for 2 <sup>nd</sup> compressor	0	999	Hr	10 Hr
CO16	Hour counter setpoint for pump/"Supply fan"	0	999	Hr	10 Hr
<b>Unloading evaporator</b>					
CO17	Unloading set point (evaporator side)	0 32	110 230	°C °F	Dec int
CO18	Unloading Differential (evaporator side)	0.1 0	25.0 45	°C °F	Dec int
CO19	Delay unloading function (evaporator side)	0	250	Sec	10 Sec
CO20	Maximum unloading operation time in case of high evaporator temperature	0	250	Sec	10 Sec
<b>Unloading condenser</b>					
CO21	Unloading pressure set point in chiller mode (condenser side)	0.0 0	50.0 725	Bar Psi	Dec int
CO22	Unloading pressure differential in chiller mode (condenser side)	0.0 0	12 174	Bar Psi	Dec int
CO23	Unloading pressure set point in heat pump mode (condenser side)	0.0 0	50.0 725	Bar Psi	Dec int
CO24	Unloading pressure differential in heat pump mode (condenser side)	0.0 0	12 174	Bar Psi	Dec int
CO25	Maximum unloading operation time in condenser side	0	250	Sec	10 Sec
<b>Water pump condenser</b>					
CO26	Condenser water pump operating mode 0= Not used 1= Continuous opeartion 2= Only for compressor demand	0	2		

CO27	Delay between condenser pump shutdown and compressor shutdown	0	250	Sec	
CO28	SET hour counter of water condenser pump	0	999	Hr	10 Hr
<b>Compressors in tandem mode</b>					
CO29	Maximum continuous operating time of a compressor	0	250	Min	
CO30	Compressor start-up delay after activation of the water solenoid valve	0	250	sec	10 Sec
<b>Modulating evaporator water pump</b>					
CO31	Peak time of modulating pump at maximum speed required by regulation	0	250	sec	
CO32	Minimum speed % of modulating pump in operation with enabled compressor (Chiller)	30	100	%	
CO33	Minimum speed % of modulating pump in operation with enabled compressor (Heat Pump)	30	100	%	
CO34	Speed % of modulating pump in operation with enabled compressor	30	100	%	
CO35	Set point modulating pump in chiller mode (evaporator outlet temperature)	-50.0 -58	110 230	°C °F	Dec int
CO36	Temperature control band for the modulating pump in chiller function	0.0 0	25.0 45	°C °F	Dec int
CO37	Delay for switching off compressor by heat regulation with water pump < 100 % in chiller function	0	250	sec	
CO38	Set point modulating pump in heat pump mode (evaporator outlet temperature)	-50.0 -58	110 230	°C °F	Dec int
CO39	Temperature control band for the modulating pump in heat pump function	0.0 0	25.0 45	°C °F	Dec int
CO40	Delay for switching off compressor by regulation with water pump < 100 % in HP function	0	250	sec	
Pr2	Password	0	999		
<b>Condenser Fan control parameter</b>					
Parameter	Description	Min	Max	Meas.	Resolution
FA01	Fan output 0= Not enabled 1= Enabled	0	1		
FA02	Fan regulation 0= On when compressor On 1= ON / OFF 2= Proportional speed control	0	2		
FA03	Fan related to compressor 0= With compressor 1= Independent from compressor	0	1		
FA04	Maximum speed time when the fan starting	0	250	Sec	
FA05	Phase difference fan	0	20	Micro Sec	250µs
FA06	Not used				
FA07	Cooling pre-ventilation before ON compressor	0	250	Sec	
FA08	Minimum fan speed in summer	30	100	%	
FA09	Maximum fan speed in summer	30	100	%	



IC100CX

FA10	Temperature / pressure setpoint for minimum speed in summer	-50.0 -58 0.0 0	110 230 50 725	°C °F Bar Psi	Decimal integer Decimal integer
FA11	Temperature / pressure setpoint for maximum speed in summer	-50.0 -58 0.0 0	110 230 50 725	°C °F Bar Psi	Decimal integer Decimal integer
FA12	Proportional band in summer	0.0 0 0.0 0	25.0 45 50.0 725	°C °F Bar Psi	Decimal integer Decimal Integer
FA13	CUT-OFF differential in summer	0.0 0 0.0 0	25.0 45 50.0 725	°C °F Bar Psi	Decimal integer Decimal integer
FA14	Override CUT-OFF in summer	0.0 0 0.0 0	25.0 45 50.0 725	°C °F Bar Psi	Decimal integer Decimal integer
FA15	Delay time for CUT-OFF	0	250	Sec	
FA16	Fan speed in summer night function	30	100	%	
FA17	Minimum fan speed in winter	30	100	%	
FA18	Maximum fan speed in winter	30	100	%	
FA19	Temperature / pressure setpoint for minimum speed in winter	-50.0 -58 0.0 0	110 230 50 725	°C °F Bar Psi	Decimal integer Decimal integer
FA20	Temperature / pressure setpoint for maximum speed in winter	-50.0 -58 0.0 0	110 230 50 725	°C °F Bar Psi	Decimal integer Decimal integer
FA21	Proportional band in winter	0.0 0 0.0 0	25.0 45 50.0 725	°C °F Bar Psi	Decimal integer Decimal integer
FA22	CUT-OFF differential in winter	0.0 0 0.0 0	25.0 45 50.0 725	°C °F Bar Psi	Decimal integer Decimal integer
FA23	Override CUT-OFF in winter	0.0 0 0.0 0	25.0 45 50.0 725	°C °F Bar Psi	Decimal integer Decimal integer
FA24	Fan speed in winter night function	30	100	%	

**Hot Start Function**

Parameter	Description	Min	Max	Meas.	Resolution
-----------	-------------	-----	-----	-------	------------

FA25	Hot Start Setpoint	-50.0 -58	110 230	°C °F	Decimal integer
FA26	Hot Start differential	0.0 0	25.0 45	°C °F	Decimal integer
Pr2	Password	0	999		
Anti-freeze / Heater parameters					
Parameter	Description	Min	Max	Meas.	Resolution
Ar01	Minimum value of Anti-Freeze Setpoint	-50.0 -58	Ar03	°C °F	Decimal integer
Ar02	Maximum value of Anti-Freeze Setpoint	Ar03	110 230	°C °F	Decimal integer
Ar03	Anti-freeze Setpoint in chiller mode	Ar01	Ar02	°C/°F	Dec/int
Ar04	Anti-Freeze Differential in chiller mode	0 0	25.0 45	°C °F	Decimal integer
Ar05	Anti-Freeze alarm delay	0	250	Sec	
Ar06	Maximum number of Anti-Freeze alarm events in 1 hour	0	16		
Ar07	Anti-Freeze alarm delay after starting in Heat Pump	0	250	Sec	
Ar08	Anti-Freeze Setpoint of the electrical heater in Chiller mode	-50.0 -58	110 230	°C °F	Decimal integer
Ar09	Anti-Freeze Setpoint of the electrical heater in Heat Pump mode	-50.0 -58	110 230	°C °F	Decimal integer
Ar10	Anti-Freeze Setpoint of external electrical heater (water/water units)	-50.0 -58	110 230	°C °F	Decimal integer
Ar11	Anti-Freeze Differential in Chiller	0 0	25.0 45	°C °F	Decimal integer
Ar12	Anti-Freeze Differential in Heat Pump	0 0	25.0 45	°C °F	Decimal integer
Ar13	Anti-freeze electrical heater regulation 0= enabled during regulation control 1= enabled active during regulation an defrost	0	1		
Ar14	Anti-freeze electrical heater regulation in Chiller mode 0= OFF in chiller 1= ON in chiller	0	1		
Ar15	Anti-freeze electrical heater regulation in H.P. mode 0= OFF in Heat Pump 1= ON in Heat Pump	0	1		
Ar16	Anti-freeze control probe in Chiller mode 0= Pb1 1= Pb2 2= PB3 probe control 3= PB4 probe control	0	3		
Ar17	Anti-freeze control probe in Heat Pump mode 0= Pb1 1= Pb2 2= PB3 probe control 3= PB4 probe control	0	3		

Ar18	"Water pump"/ "Anti-freeze electrical heater" control with unit in OFF or Stand-by 0= Regulation not enabled 1= Regulation enabled 2= Regulation of water pump/anti-freezer on probe PB4 configured as esternal temperature probe 3= Regulation of water pump / anti-freezer heaters on probe PB4 and separate set points	0	3		
Ar19	"Water pump"/ "Anti-freeze electrical heater" control for faulty probe 0= output OFF for faulty probe 1= output ON for faulty probe	0	1		
Boiler Function					
Parameter	Description	Min	Max	Meas.	Resolution
Ar20	Boiler function 0= Integration control 1= Heating control	0	1		
Ar21	External air Setpoint for Boiler heater activation	-50.0 -58	110 230	°C °F	Decimal integer
Ar22	Boiler function differential	0 0	25.0 45	°C °F	Decimal integer
Ar24	Activation delay time of heater n° 2	0	250	Min	
Ar25	Outside air set point for disabling the compressors	-50.0 -58	110 230	°C °F	Dec Int
Ar26	Outside air differential for enabling the compressors	0 0	25.0 45	°C °F	Dec int
Anti-freezer alarm in HP function					
Ar27	Anti-freeze alarm set point in heat pump mode	Ar01	Ar02	°C /°F	Dec/int
Ar28	Anti-freeze alarm differential in heat pump mode	0 0	25.0 45	°C °F	Dec int
Evaporator water pump functioning / condenser of ambient probe					
Ar29	Evaporator/condenser water pump set point with external temperature regulation	-50.0 -58	110 230	°C °F	Dec int
Ar30	Evaporator/condenser water pump differential with external temperature regulation	0.1 0	25.0 45	°C °F	Dec int
Condenser water pump functioning					
Ar31	Regulation of condenser water pump/ anti-freeze heaters in OFF – standby mode. 0= de-activated 1= Switched on in OFF or standby mode 2= Regulation of water pump/ anti-freeze heaters with probe PB4 configured as ambient probe 3= Regulation of the water pump / anti-freeze heaters with probe PB4 configured as ambient probe and separate set points.	0	3		
Ar32	Activation of condenser water pump / anti-freeze heaters in case of probe failure. 0= Off with probe fault 1= On with probe fault	0	1		
Pr2	Password	0	999		
Defrost Parameters					
Parameter	Description	Min	Max	Meas.	Resolution

DF01	Defrost control 0= No 1= Yes	0	1		
DF02	Defrost type 0= Temperature / pressure 1= Time 2= External contact	0	2		
DF03	Temperature / pressure Setpoint for starting the defrost cycle	-50.0 -58 0.0 0	110 230 50 725	°C °F Bar Psi	Decimal integer Decimal integer
DF04	Temperature / pressure Setpoint for stopping the defrost cycle	-50.0 -58 0.0 0	110 230 50 725	°C °F Bar Psi	Decimal integer Decimal integer
DF05	Minimum delay time before starting a forced defrost cycle	0	250	Sec	
DF06	Minimum defrost duration	0	250	Sec	
DF07	Maximum defrost duration	0	250	Min	
DF08	Compressor Off time before starting a defrost cycle	0	250	Sec	
DF09	Compressor Off time after a defrost cycle	0	250	Sec	
DF10	Interval time between defrost cycles	0	99	MIN	
DF11	Temperature setpoint to start a combined defrost cycle after the DF10 counting time	-50.0 -58	110 230	°C °F	Decimal integer
DF12	Temperature Setpoint to stop a combined defrost	-50.0 -58	110 230	°C °F	Decimal integer
DF13	Forced activation of the 2 <sup>nd</sup> compressor in defrost 0= Not enabled 1= Enabled	0	1		
DF14	Forced fan activation during defrost and draining times 0= Not enabled 1= Enabled only for defrost 2= Enabled for defrost and draining time (dF09)	0	2		
DF15	Temperature/Pressure Setpoint to start a forced condensing fan control in defrost cycle	-50.0 -58 0.0 0	110 230 50 725	°C °F Bar Psi	Decimal integer Decimal integer
DF16	Low alarm control during defrost 0= Not enabled 1= Enabled	0	1		
DF17	Low alarm delay time after changing the status of the 4-ways valve	0	250	Sec	
DF18	4-ways reversing valve 0= ON in cooling 1= ON in heating	0	1		
DF19	Temperature/pressure Setpoint to start a forced defrost cycle	-50.0 -58 0.0 0	110 230 50 725	°C °F bar psi	Decimal integer Decimal integer
DF20	Forced defrost cycle differential	0 0	25.0 45	°C °F	Decimal integer
Pr2	Password	0	999		
<b>Alarm Parameter</b>					

Parameter	Description	Min	Max	Meas.	Resolution
AL01	Low pressure alarm delay time	0	250	Sec	
AL02	Maximum low pressure alarm events in 1 hour	0	16		
AL03	Low pressure alarm with off compressor 0= Not enabled when compressor Off 1= Enabled when compressor Off	0	1		
AL04	"Water flow/Supply fan thermal protection" alarm delay after "water pump / supply air fan" starting.	0	250	Sec	
AL05	Maximum duration of the flow switch alarm before it becomes manual and blocks the water pump	0	250	Sec	
AL06	"Water flow/Supply fan thermal protection" input activation duration	0	250	Sec	
AL07	"Water flow/Supply fan thermal protection" input de-activation duration	0	250	Sec	
AL08	Thermal protection alarm delay after starting the compressor	0	250	Sec	
AL09	Number of maximum thermal protection alarm events.	0	16		
AL10	Maximum number of high temperature / condenser pressure alarm interventions per hour	0	16		
AL11	Condensing temperature/pressure high alarm setpoint for input probe	-50.0 -58 0.0 0	110 230 50 725	°C °F Bar Psi	Decimal integer Decimal integer
AL12	Temperature/pressure high alarm differential for input probe	0 0 0 0	25.0 45 50.0 725	°C °F Bar Psi	Decimal integer Decimal integer
AL13	Low pressure alarm delay for input probe	0	250	Sec	
AL14	Low pressure alarm Setpoint for input probe	-50.0 -58 0.0 0	110 230 50 725	°C °F Bar Psi	Decimal integer Decimal integer
AL15	Low pressure differential for input probe	0 0 0 0	25.0 45 50.0 725	°C °F Bar Psi	Decimal integer Decimal integer
AL16	Maximum number of the low alarm events in 1 hour for input probe	0	16		
AL17	Alarm relay and buzzer activation when the unit is Off or stand-by 0= Alarm relay and buzzer enabled 1= Alarm relay and buzzer disabled	0	1		
AL18	Alarm relay output/open collector polarity 0= Output without voltage in normal conditions, with voltage when there is an alarm 1= Output with voltage in normal conditions, without voltage when there is an alarm	0	1		

IC100CX

<b>AL19</b>	Allows to choose the probe for the anti- freezer heater alarm. 0= Relative to Ar16 parameters in chiller mode - Ar17 in hp. 1= on Pb1 probe 2= on Pb2 probe 3= on Pb3 probe 4= on Pb4 probe	0	4		
<b>AL20</b>	Maximum number of general unit block alarm interventions per hour	0	16		
<b>AL21</b>	General alarm delay starting from digital input activation	0	250	Sec	
<b>AL22</b>	Delay to reset the general alarm starting from digital input de-activation	0	250	10 sec	10 sec
<b>AL23</b>	General alarm type: 0 = signaling only does not depend on AL20 (alarm relay and buzzer enabled), always reset automatically 1= the alarm blocks the unit; resetting of the alarm depends on the value of the AL20 parameter	0	1		
<b>AL24</b>	System's inlet water high temperature alarm set point	-50.0 -58 0.0 0	110 230 50.0 725	°C °F Bar Psi	Dec int Dec int
<b>AL25</b>	System's inlet water high temperature alarm differential	0 0 0 0	25.0 45 50.0 725	°C °F Bar Psi	Dec int Dec int
<b>AL26</b>	Delay time for signaling the system's inlet water high temperature alarm	0	250	10 sec	10 sec
<b>AL27</b>	Maximum number of system inlet high temperature alarm interventions per hour	0	16		
<b>AL28</b>	Condenser water flow alarm delay time	0	250	Sec	
<b>AL29</b>	Maximum duration of the flow switch alarm before it becomes manual and blocks the water pump	0	250	Sec	
<b>AL30</b>	Minimum activation time for water flow alarm	0	250	Sec	
<b>AL31</b>	Minimum time with inactive water flow input (after alarm event).	0	250	Sec	
<b>AL32</b>	Condenser flow switch alarm configuration 0= not used 1= activated only in chiller mode 2= activated only in h.p. mode 3= activated in chiller and h.p. mode	0	3		
<b>Pr2</b>	Password	0	999		

## 21. TECHNICAL DATA

**Housing:** Self extinguishing ABS  
**Case:** Front panel 32x74 mm, depth 60mm  
**Mounting :** 29x71 mm panel cut-out  
**Frontal protection:** IP65  
**Connections:** Removable terminal block 12 and 14 ways  
**Power supply:** 12Vac/dc  $\pm$  10%, 24Vac/dc  $\pm$  10%, 50-60Hz  
**Power absorption:** 5VA max  
**Inputs:** 4 NTC probes, or 3 NTC probes and one 4..20mA / 0..10V  
**Digital inputs:** 5 free voltage  
**Relay outputs:** 4 / 5 relays (depending on the model) SPDT 5(3)A, 250Vac  
**Open collector:** 12V, 40mA  
**Analogue output:** 4..20mA / 0..10V  
**Serial output :** TTL standard  
**Communication protocol:** Modbus – RTU  
**Data storing:** on the non-volatile memory (EEPROM)  
**Kind of action:** 1B  
**Pollution grade:** normal  
**Software class:** A  
**Operating temperature:** 0+60 °C  
**Storage temperature:** -25+60 °C  
**Relative humidity:** 20-85% (no condensing)  
**Measuring range:** NTC probe -40+110°C C (- 40 + 230 °F)  
**Measuring range:** pressure trasducers 0+ 50 bar  
**Temperature resolution:** 0,1 °C or 1°C  
**Accuracy (ambient temp. 25°C):**  $\pm$ 0,5 °C  $\pm$ 1 digit

Input/output		Tipo
Probes	Pb1, Pb2 e Pb4	Configurable: NTC, Digital input
	Pb3	Configurable: NTC, 4..20mA, 0..5V
Digital inputs	ID1, ID2 e ID5	Configurable; free voltage
	ID3	High pressure; free voltage
	ID4	Low pressure; free voltage
Relays	RL1	For compressor: relay SPDT 5(3) A 250Vac
	RL2, RL3, RL4 e RL5	Configurable: relè SPDT 5(3) A 250Vac
PWM output / open collector		PWM: modulation of the evaporator fan, open collector: configurable
Open collector output		Configurable; 12 Vcc 40mA max
4..20mA or 0..10V output		Modulation of the evaporator fan or modulation of the evaporator pump
Hot Key / TTL output		Output for Hot Key or Personal computer / supervisor systems
Remote keyboard		Output for remote keyboard

Dixell s.r.l. Z.I. Via dell'Industria, 27  
 32010 Pieve d'Alpago (BL) ITALY  
 tel. +39 - 0437 - 98 33 - fax +39 - 0437 - 98 93 13  
 E-mail: dixell@dixell.com - <http://www.dixell.com>