

Installation guide

Thermostat

Types CAS 178, CAS 180, CAS 181

060R9305

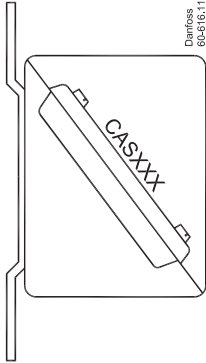

Danfoss
60L375.11

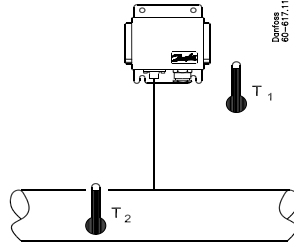

Danfoss
60L377.11

Type	T ₂ max.	T ₁ min.	T ₁ max.
	[°C]		
CAS 178	130	-25	70
CAS 180	220		
CAS 181	250		

060R9305

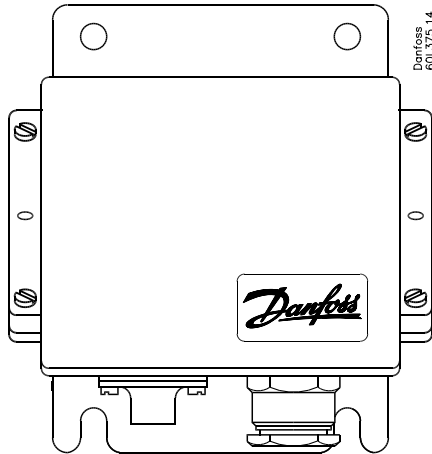

Danfoss
60L375.14

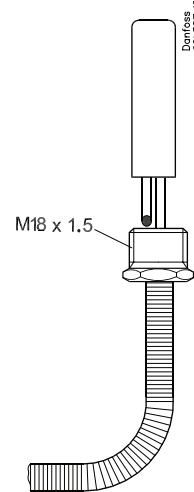

Danfoss
60L397.12

Danfoss
A60-386.12

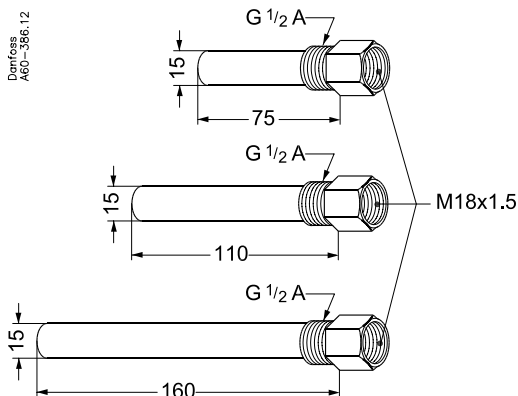

L [mm]	Code no.	
	Brass	Steel 18/8
75	060L326266	060L326766
110	060L327166	060L326866
160	060L326366	060L326966

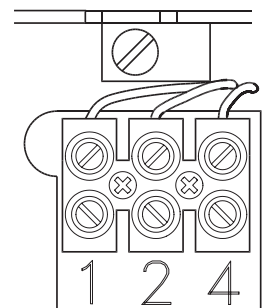
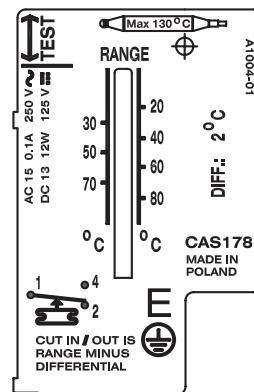

Danfoss
60L1049.11

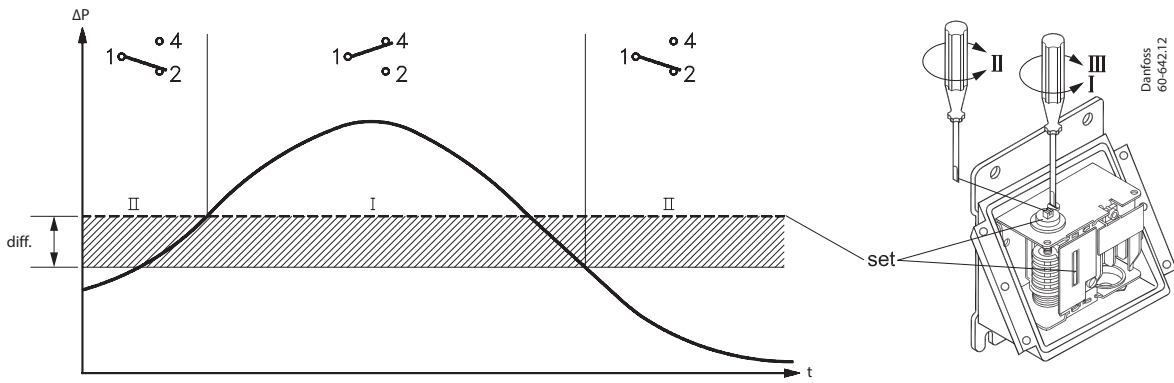

Diff.: 0.1 bar

Type	Diff. [°C]
CAS 178	2.0
CAS 180	
CAS 181	2.5

